

# Dynabelter® Series

## Air-Powered Abrasive Belt Machines

*Grind • Deburr • Blend • Clean • Finish • Polish*

### Excellent For...

- Custom Metal Fabrication
- Grinding & Deburring Radiuses
- Grinding Handrails
- Structural Steel Preparation
- Stainless Steel Polishing
- Grinding & Cleaning Welds
- Deburring Tubing
- Various Fabrication Projects

### For Use On...

- Stainless Steel • Aluminum
- Sheet Metal • Die Castings
- Non-Ferrous Metals • Chrome
- Tempered Glass • Much More

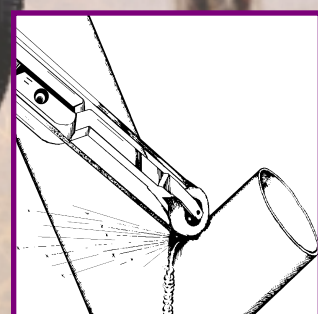
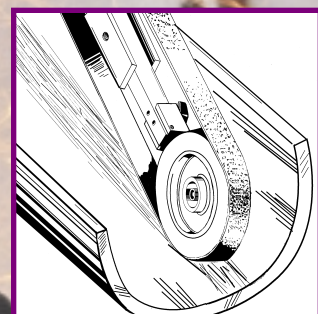
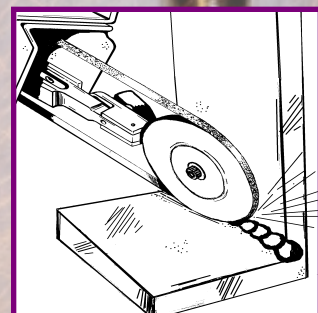
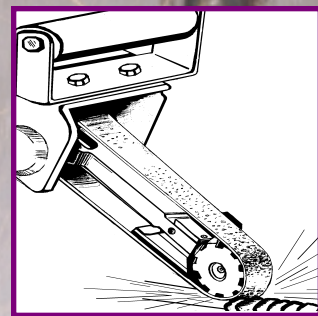

*Continued leadership in abrasive power tool technology...*



# Dynabelter® Air-Powered Abrasive Belt Machines

Work on ferrous and non-ferrous metals, wood, plastic, stone and many composites.

- Grind cylinders; deburr castings.
- Polish tubing; deburr structural steel.
- Piping and stainless fabrication.
- Fabricate metals; clean welds.
- Finish dimension on lathe work.
- Blend inside corners.



Placing the Dynabelter motor handle at a 45° angle from the belt housing will increase pressure while grinding with the tool. The Dynabelter is designed to be pulled toward the operator, working off the return side of the belt, for faster weld removal. Serrated contact wheels provide more aggressive stock removal by utilizing greater unit pressure.

## Fast, Easy Contact Arm And Abrasive Belt Change!

- 1 Remove pop-off cover.
- 2 Remove abrasive belt.
- 3 Unscrew adjustment knob and replace arm.

- 1 Remove pop-off cover.
- 2 Release belt tension lever.
- 3 Pull belt back and left to release from drive wheel.

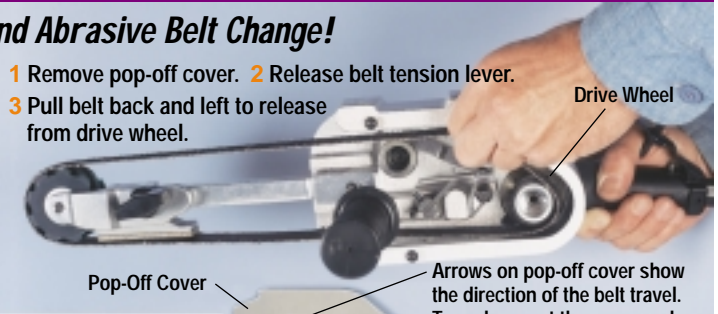

Arrows on pop-off cover show the direction of the belt travel. To replace, put the cover under two screws located on the belt housing, straddle the grommet with thumbs and push down.

## Table of Contents Dynabelter Models

Standard, Heavy-Duty, Extra Heavy-Duty and Versatility Kits	Pg. 3
Heavy and Extra-Heavy Duty Accu-Grinders (Adjust-A-Wheel)	Pg. 4
Heavy-Duty Accu-Grinder with Hula-Guide Adjustment	Pg. 5
Dynabelter Finisher	Pg. 5
<b>Accessories &amp; Abrasives</b>	
Dynabelter Contact Arms	Pg. 6
Dynaflex Contact Arms	Pg. 7
Contact Wheels and Assemblies	Pg. 8
Dynapad Platen Pads	
Bench Mount and Foot Pedal	Pg. 9
Dynūba Belt Treatments	
Abrasives and Polishing Belts	
Motor Tune-Up Products	Pg. 10
Dynabrade Air Line Lube	
Filter-Regulator-Lubricator	
Dynaswivel Air Line Connector	Pg. 11
Flexible Air Lines	
Dynabelter Instructional Video	Pg. 12

*Model 11476 grinds weld seam; leaves in-line scratch pattern.*

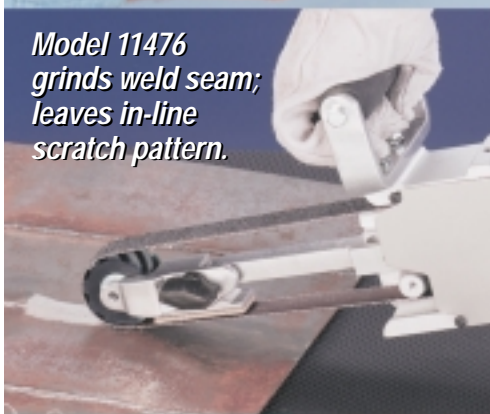

*11684 Contact Arm for contour polishing without gouging.*



*Model 11475 allows grinding of circumferential weldments.*

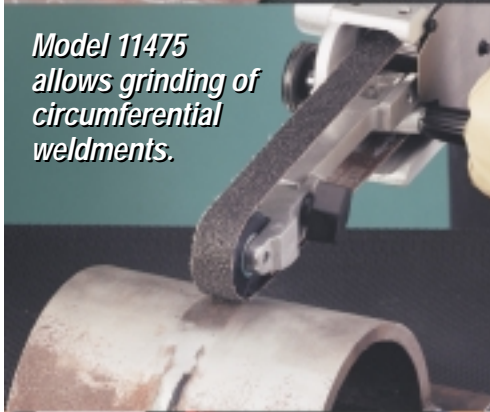

*11894 Contact Arm strap polishes tubes and pipes up to 7" diameter.*



*Model 11489 has Hula-Guide for precise depth of cut.*



*Model 11486 features Adjust-A-Wheel to prevent undercutting.*

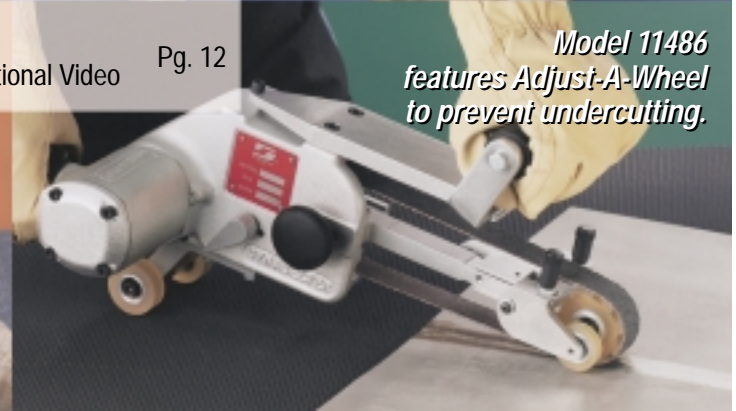

### Model 11475 Standard Duty

- Uses 1/4"-1" (6-25mm) wide x 30" (762mm) long abrasive belts, see page 10.
- Includes 11681 Contact Arm assembly, see page 6.
- Standard duty air motor with adjustable speed.
- Removable side handle. • Safety-lock lever throttle.
- Optional 80022 Bench Mount available, see page 9.
- 96045 Motor Tune-Up Kit available, see page 10.



Model 11475

### Model 11476



### Model 11476 Heavy-Duty

- Uses 1/4"-1" (6-25mm) wide x 30" (762mm) long abrasive belts, see page 10.
  - Includes 11681 Contact Arm Assembly, see page 6.
  - Heavy-duty air motor.
  - Top control handle. • Safety-lock lever throttle.
  - Optional 80022 Bench Mount available, see page 9.
  - 96011 Motor Tune-Up Kit available, see page 10.
- Note:** Tool speed is 4,220 SFPM (1,297 SMPM); a 3,050 SFPM (929.6 SMPM) tool is available.

### Model 11477 Extra Heavy-Duty

- Uses 1"-2" (25-51mm) wide x 30" (762mm) long abrasive belts, see page 10.
- Includes 11870 Contact Arm Assembly, see page 6.
- Extra heavy-duty air motor with safety-lock lever throttle.
- Pressure bar with top control handle.
- A 11871 Contact Arm with 4" (102mm) dia. contact wheel is available for 2" (51mm) wide x 60" (1,524mm) long belts providing a 20" (508mm) workable reach, see page 6. Optional 11891 Platen is available for the 11871 Arm.
- Optional 80022 Bench Mount available, see page 9.
- 96259 Tune-Up Kit available, see page 10.

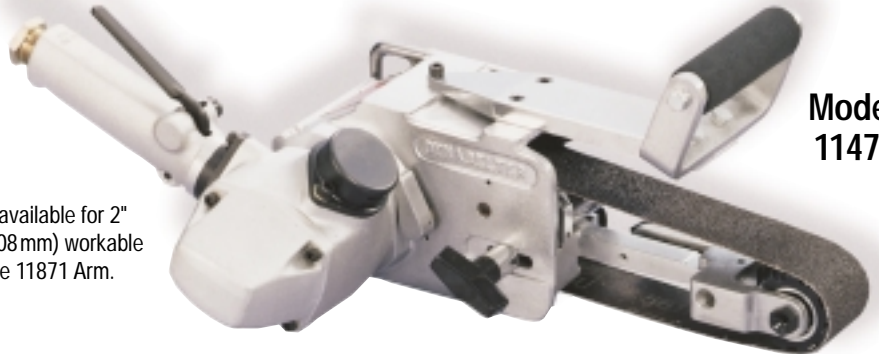

Model 11477

Machine Number	Length Inch (mm)	Height Inch (mm)	Weight Pound (kg)	Abrasive Belt Size Inch (mm)	Air Flow Rate SCFM (LPM)	Air Inlet Thread	Sound Level	Motor HP (W)	Motor RPM	Max. SFPM (SMPM)
11475	21" (533)	7-1/4" (184)	7-1/2 lbs. (3.4)	1/4" - 1" (6-25) W x 30" (762) L	30 (850)	1/4" (6 mm) NPT	94 dBA	.45 (336)	18,000	5,890 (1,789)
11476	21" (533)	7-1/4" (184)	8 lbs. (3.6)	1/4" - 1" (6-25) W x 30" (762) L	58 (1,643)	3/8" (9 mm) NPT	92 dBA	1.02 (761)	13,000	4,254 (1,297)
11477	21-1/2" (546)	7-3/4" (197)	14 lbs. (6.4)	1" - 2" (25-51) W x 30" (610) L	70 (1,982)	3/8" (9 mm) NPT	84 dBA	1.8 (1,342)	7,200	4,710 (1,431)

**Additional specifications:** Air Pressure 90 PSI (6.2 Bars) • Hose Size: for 11475 and 11476, 3/8" (9 mm); for 11477, 1/2" (13 mm)

### 11480 Standard Duty and 11481 Heavy-Duty Dynabelter Versatility Kits

- Includes either 11475 Standard or 11476 Heavy-Duty machine, contact arms (shown below), Dynapad® platen pads and a variety of 1/2" (13mm) and 1" (25mm) wide abrasive belts.
- 11481 Kit has U.S. Government National Stock No. 5130010693790.

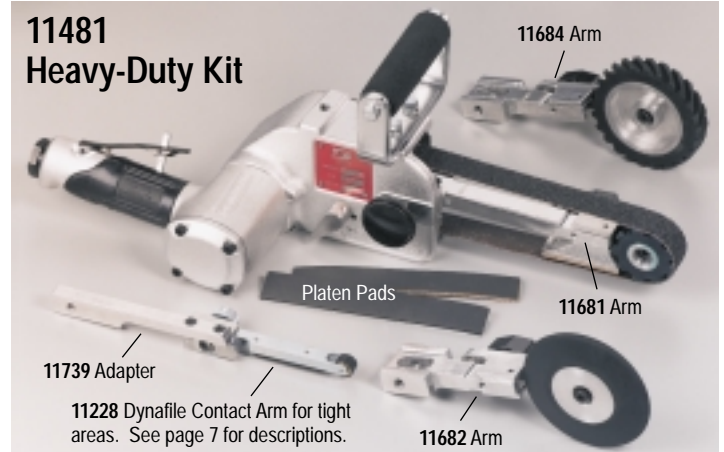
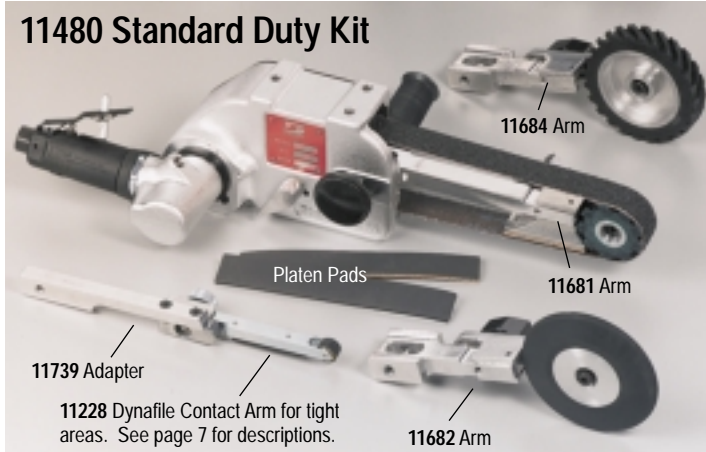

11739 Adapter is included in Dynabelter Kits! Allows smaller Dynaflex arms to be mounted, see page 7.

# Dynabelter® Accu-Grinder® with Adjust-A-Wheel

*Grinds welds flat... without undercutting.*

**Model 11486**



## Model 11486 Heavy-Duty For 1" (25mm) x 30" (762mm) Belts

- The Accu-Grinder is designed to efficiently remove excess weld material and leave a narrow "in-line" scratch pattern.
- Each Accu-Grinder features adjustable guide tires which control the depth of abrasive belt cut. Set depth of cut and pull back over weld. Take the guesswork out of weld grinding and prevent undercutting with this unique guide-grinding tool. Excellent for controlled grinding on flats, contours and inside/outside of pipes and tanks.
- Has 11717 Adjust-A-Wheel Contact Arm with 2" (51mm) dia. x 1" (25mm) wide 90-duro standard serrated contact wheel, see pg. 6.

### Simple Twist-Knobs Adjust Depth of Weld Cut

#### Work on Longitudinal Welds:

- I.D. — 12" (305mm) or larger pipe, O.D. — 8" (203mm) or larger pipe.

#### Work on Circumferential Welds:

- I.D. — 22" (559mm) or larger pipe, O.D. — 12" (305mm) or larger pipe.

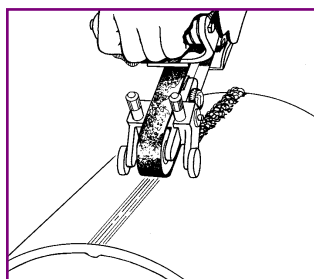
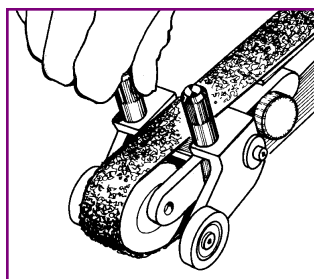

Machine Number	Length Inch (mm)	Height Inch (mm)	Weight Pound (kg)	Abrasive Belt Size Inch (mm)	Air Flow Rate SCFM (LPM)	Air Inlet Thread	Sound Level	Motor HP (W)	Motor RPM	Max. SFPM (SMPM)
11486	22" (559)	7" (178)	9 lbs. (4)	1" (25) W x 30" (762) L	58 (1,643)	3/8" (9 mm) NPT	89 dBA	1.02 (761)	13,000	4,220 (1,282)

Additional specifications: Hose Size 1/2" (13 mm) • Air Pressure 90 PSI (6.2 Bars)

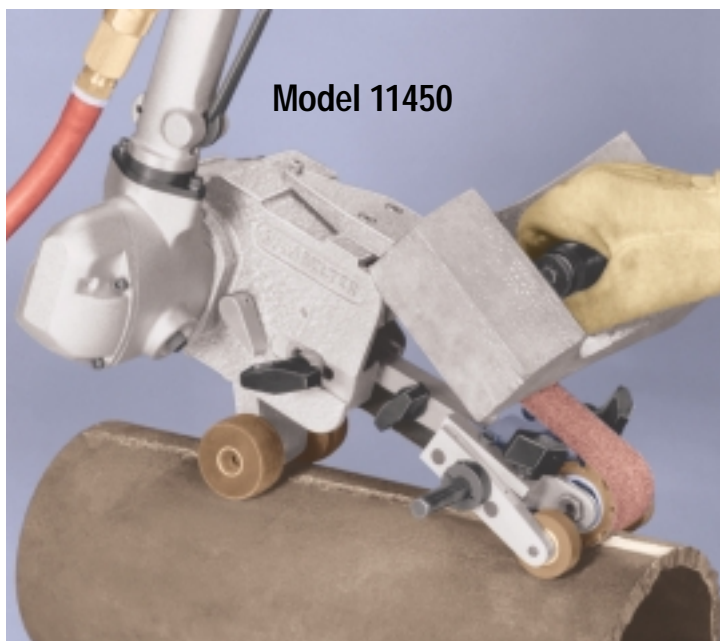

**Model 11450**

## Model 11450 Extra Heavy-Duty For 2" (51mm) x 30" (762mm) Belts

- Includes 11961 Adjust-A-Wheel Contact Arm with 2" (51mm) dia. x 2" (51mm) wide 90-duro standard serrated urethane contact wheel.
- Has rear support wheels. Pressure bar accepts optional 25 lb. (11.4 kg) weight (95195) to maintain consistent grinding force over the contact wheel.

### Simple Twist-Knobs Adjust Depth of Weld Cut

#### Work on Longitudinal Welds:

- I.D. — 16" (406mm) diameter pipe or larger.
- O.D. — 12" (305mm) diameter pipe or larger.

#### Work on Circumferential Welds:

- I.D. — 18" (457mm) diameter pipe or larger.
- O.D. — 20" (508mm) diameter pipe or larger.



The Adjust-A Wheel contact arm should always be used in conjunction with the back wheel supports for accurate control of the depth of cut.

Machine Number	Length Inch (mm)	Height Inch (mm)	Weight Pound (kg)	Abrasive Belt Size Inch (mm)	Air Flow Rate SCFM (LPM)	Air Inlet Thread	Sound Level	Motor HP (W)	Motor RPM	Max. SFPM (SMPM)
11450	20" (508)	9" (229)	18 lbs. (8.2)	2" (51) W x 30" (762) L	70 (1,982)	3/8" (9 mm) NPT	86 dBA	1.9 (1,417)	7,200	4,710 (1,431)

Additional specifications: Hose Size 1/2" (13 mm) • Air Pressure 90 PSI (6.2 Bars)

*Circumferential grinding on any pipe or tank without undercutting.*

## Model 11489 Heavy-Duty For 1" (25 mm) x 30" (762 mm) Belts

Has heavy-duty air motor and includes a 11890 Hula-Guide Contact Arm with 2" (51 mm) diameter x 1" (25 mm) wide 90-durometer standard serrated urethane contact wheel.

### Features

- Works on circumferential and flat surface welds to leave in-line scratch pattern.
- The special Hula-Guide guide tires remain parallel with the contact wheel allowing operator to tilt machine at any angle without undercutting.
- Safety-lock lever throttle; pressure bar.
- Work on circumferential welds: I.D. of 22" (559 mm) diameter or larger pipe. O.D. of any diameter pipe.

### Here's How Hula-Guide Works

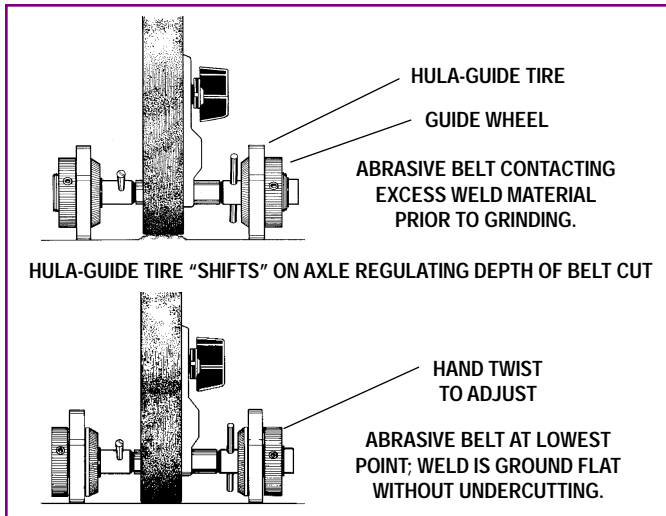

### Purpose:

The Hula-Guide system provides accurate weld grinding without undercutting, especially on circumferential applications, no matter what abrasive belt grit is used.

### Hula-Guide Tires:

The Hula-Guide Tires are mounted on the contact arm axle on each side of the contact wheel. The Hula-Guide Tires "shift" on the axle, allows for varying depth of abrasive belt cut ranging from "on-work" surface to 5/32" (4 mm) above the surface.

### To Raise Abrasive Belt:

Tighten guide wheels to shift Hula-Guide Tires to desired grinding height. "Zero-in" on exact height using minute guide wheel adjustments. Tires lock in place.

### To Lower Abrasive Belt:

Loosen guide wheels to shift Hula-Guide Tires. At lowest point, abrasive belt rests on parent metal.

The Hula-Guide contact arm allows the operator to tilt the machine at any angle without undercutting.



Machine Number	Length Inch (mm)	Height Inch (mm)	Weight Pound (kg)	Abrasive Belt Size Inch (mm)	Air Flow Rate SCFM (LPM)	Air Inlet Thread	Sound Level	Motor HP (W)	Motor RPM	Max. SFPM (SMPM)
11489	22" (559)	7" (178)	9 lbs. (4)	1" (25) W x 30" (762) L	58 (1,643)	3/8" (9 mm) NPT	90 dBA	1.02 (761)	13,000	4,220 (1,282)

Additional specifications: Hose Size 1/2" (13 mm) • Air Pressure 90 PSI (6.2 Bars)

## Dynabelter® Finisher

*Easy finishing on crankshafts, cylinders and contours using the slack of the belt.*

## Model 11462 For 1" (25 mm) x 60" (1,524 mm) Belts

- Features standard power air motor with adjustable speed.
- Work off slack of belt or contact wheel. The 11601 Contact Arm Assembly reaches a full 20" (508 mm) and includes a 4" (102 mm) dia. x 1" (25 mm) wide 40-durometer smooth rubber contact wheel and 1" (25 mm) wide x 2-1/2" (63 mm) long Dynapad platen (adjustable and removable).

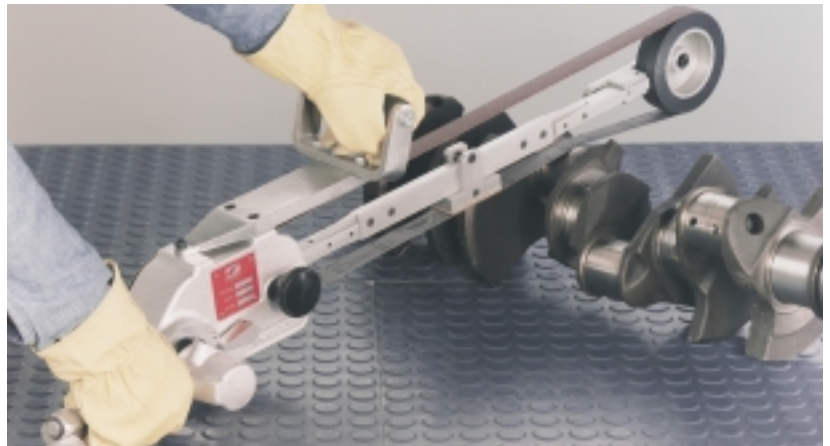

Machine Number	Length Inch (mm)	Height Inch (mm)	Weight Pound (kg)	Abrasive Belt Size Inch (mm)	Air Flow Rate SCFM (LPM)	Air Inlet Thread	Sound Level	Motor HP (W)	Motor RPM	Max. SFPM (SMPM)
11462	29" (737)	12-1/2" (318)	8 lbs. (3.6)	1" (25) W x 60" (1,524) L	30 (850)	1/4" (6 mm) NPT	83 dBA	.45 (336)	18,000	5,890 (1789)

Additional specifications: Hose Size 3/8" (9 mm) • Air Pressure 90 PSI (6.2 Bars)

# Dynabelter® Standard Contact Arms

Contact wheels noted include bearing, spacer and shaft.

Choose from a variety of contact wheels and wheel assemblies.



**Belt Size:** 1" (25mm) wide x 30" (762mm) long.  
**11650 Contact Wheel:** 2" (51mm) diameter x 1" (25mm) wide, 70 durometer standard serrated urethane.  
**11605 Platen:** 1" (25mm) wide x 2-1/2" (63mm) long. 7-1/2" (190mm) workable reach. 11672 Contact Arm Assembly available; same as 11681 except with 90-duro contact wheel.  
**Note:** The higher the durometer the harder the wheel.

## 11870



**Belt Size:** 2" (51mm) wide x 30" (762mm) long.  
**11847 Contact Wheel:** 2" (51mm) diameter x 2" (51mm) wide 70 durometer standard serrated urethane.  
**Platen:** Optional 11659 Platen Assembly, available for mounting 2" (51mm) wide x 2-1/2" (63mm) long Dynapad platen; has 7" (178mm) workable reach. 11872 Contact Arm Assembly available; same as 11870 except with 90-duro contact wheel.  
**Note:** 2" (51mm) diameter x 2" (51mm) wide urethane wheel assemblies are for extra heavy-duty machines only.

Urethane Wheel Assemblies			
Available For 11681. 2" (51mm) Dia. x 1" (25mm) Wide.			
Durometer	Serration	Color	Part No.
90	Scoop	Amber	11614
90	Standard	Amber	11618
80	Standard	Blue	11652
70	Standard	Green	11650
60	Standard	Red	11648

Urethane Wheel Assemblies			
Available For 11870. 2" (51mm) Dia. x 2" (51mm) Wide.			
Durometer	Serration	Color	Part No.
90	Standard	Amber	11851
70	Standard	Green	11847
70	Scoop	Green	11849
90	Scoop	Amber	11853

# Dynabelter® Optional Contact Arms

## 11663



**11605 Platen:** 1" (25mm) wide x 2-1/2" (63mm) long.  
**Belt Size:** 1" (25mm) wide x 30" (762mm) long.  
**11616 Contact Wheel:** 1" (25mm) dia. x 1" (25mm) wide 80 durometer smooth rubber.

- Grind, deburr, polish over Dynapad platen.
- 7-1/2" (190mm) workable reach.

## 11668 Stroke Sander



**11605 Platen:** 1" (25mm) wide x 1-7/8" (47.6mm) long.  
**Belt Size:** 1" (25mm) wide x 30" (762mm) long.  
**11616 Contact Wheels:** (2) 1" (25mm) wide x 1" (25mm) dia. 80 duro smooth rubber.

- Wheel mount pivots to maintain surface contact.
- Work on broad areas, blend stainless.
- Leaves "in-line" scratch pattern.
- 6" (152mm) workable reach.

## 11677



**Platen:** None  
**Belt Size:** 1" (25mm) wide x 30" (762mm) long.  
**11620 Contact Wheel:** 4" (102mm) diameter x 1" (25mm) wide 40 duro smooth rubber, (80 duro available).

- Grind, blend, polish welds; strap polish using slack of belt.
- 7" (178mm) workable reach.

## 11682



**Platen:** None  
**Belt Size:** 1/2" (13mm) or 1" (25mm) wide x 30" (762mm) long.  
**11638 Contact Wheel:** 4" (102mm) diameter x 1/2" (13mm) wide 70 durometer radiused rubber.

- Grind, deburr fillet welds, inside corners.
- 7" (178mm) workable reach.

## Contact Arm Extenders allow for longer belts.

- These extenders allow Dynabelter contact arms to use longer abrasive belts and provides a longer workable reach.

**11656** For 42" (106.7cm) long belts, 13" (330mm) reach.

**11657** For 54" (137.2cm) belts, 19" (483mm) reach.

**6 11679** For 60" (152.4cm) belts, 21" (533mm) reach.



## 11684



**Platen:** None  
**Belt Size:** 1" (25mm) wide x 30" (762mm) long.  
**11642 Contact Wheel:** 4" (102mm) diameter x 5/8" (16mm) wide 40 durometer serrated rubber. (60, 80, 90 durometer urethane wheels available).

- Polish contours without gouging workpiece.
- Ideal for stainless pipe.
- 7" (178mm) workable reach.

## 11717 Adjust-A-Wheel

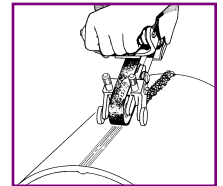
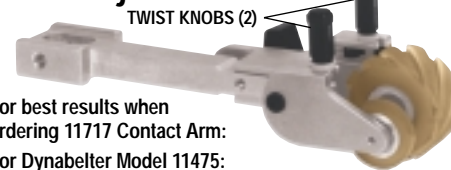

**For best results when ordering 11717 Contact Arm:**  
**For Dynabelter Model 11475:** Add 11705 Pressure Bar Assembly and 11794 Back Wheel Assembly.  
**For Model 11476:** Add 11544 Pressure Bar, (3) 95150 Mounting Screws, 11794 Assembly.  
**Platen:** None. **Belt Size:** 1" (25mm) wide x 30" (762mm) long.  
**11618 Contact Wheel:** 2" (51mm) dia. x 1" (25mm) wide 90-duro standard serrated urethane.

## 11871 For use with extra heavy-duty model 11477 only.

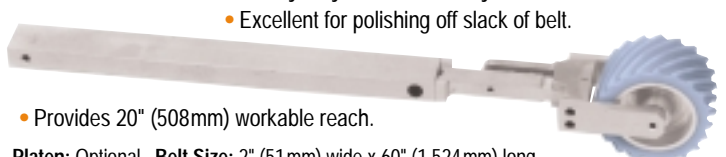

- Excellent for polishing off slack of belt.
- Provides 20" (508mm) workable reach.

**Platen:** Optional. **Belt Size:** 2" (51mm) wide x 60" (1,524mm) long.  
**11902 Contact Wheel:** 4" (102mm) dia. x 2" (51mm) wide 80-duro scoop serrated urethane.

## 11894



**For use with extra heavy-duty models 11450 and 11477 only.**  
**Platen:** None. **Belt Size:** 2" (51mm) wide x 34" (864mm) long.  
**11902 Contact Wheel:** 4" (102mm) dia. x 2" (51mm) wide 80-duro scoop serrated urethane.

- Provides 9" (229mm) workable reach. Grind off contact wheel.
- Excellent for polishing off slack of belt.

## Mount Dynafile Contact Arms on the 11475 and 11476 Dynabelters!



### 11739 Adapter Accepts smaller contact arms!

For work in small areas using 30" (762mm) long belts.  
Allows 8" (203mm) workable reach.

**11212** 45 PSI maximum (3.1 Bars). • Round openings as small as 7/16" (11 mm).

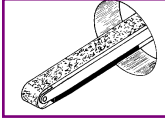

11034 Platen: 1/4" (6mm) wide.  
Belt Size: 1/4" (6mm) wide.

11066 Contact Wheel: 5/16" (8mm) diameter x 1/8" (3mm) wide, steel.

**11219** • No platen due to offset design. Grind radiuses, slack polish.

Offset for slack polishing.



No Platen

Belt Size: 1/4" (6mm), 5/16" (8mm) or 1/2" (13mm) wide.

11080 Contact Wheel: 1" (25mm) diameter x 3/8" (9mm) wide, radiused rubber.

**11213** 45 PSI (3.1 Bars) maximum. • See 11239 for heavy-duty version.

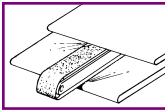

11027 Platen: 1/2" (13mm) wide. Belt Size: 1/2" (13mm) wide.

11068 Contact Wheel: 5/16" (8mm) diameter x 3/8" (9mm) wide, steel.

**11228 Heavy-Duty Steel** • Optional 11028 Steel Platen for grinding.

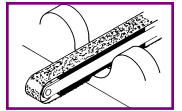

11025 Platen: 1/2" (13mm) wide. Belt Size: 1/2" (13mm) wide.

11078 Contact Wheel: 5/8" (16mm) diameter x 3/8" (9mm) wide, rubber.

**11214** 45 PSI (3.1 Bars) maximum. • Work on contact wheel or Dynapad®.

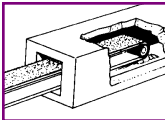

11025 Platen: 1/2" (13mm) wide. Belt Size: 1/2" (13mm) wide.

11070 Contact Wheel: 7/16" (11mm) diameter x 3/8" (9mm) wide, rubber.

**11231** • See 11243 for heavy-duty version.

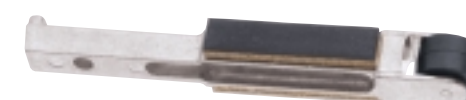

11135 Platen: 1/2" (13mm) wide. Belt Size: 1/2" (13mm) wide.

11084 Contact Wheel: 3/4" (19mm) diameter x 1/2" (13mm) wide, rubber.

• Enter 1/2" (13mm) x 1/2" (13mm) openings.

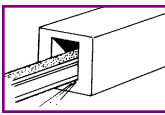

11034 Platen: 1/4" (6mm) wide. Belt Size: 1/4" (6mm) wide.

11072 Contact Wheel: 7/16" (11mm) diameter x 1/8" (3mm) wide, brass.

**11232** • No platen due to offset design. Grind corners, strap polish.

V-Tapered

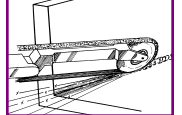

No Platen. Belt Size: 1/4" (6mm) wide.

11086 Contact Wheel: 1" (25mm) diameter x 3/8" (9mm) wide, tapered urethane.

• Enter 5/16" (8mm) x 3/4" (19mm) openings.

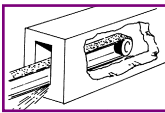

11032 Platen: 1/4" (6mm) wide. Belt Size: 1/4" (6mm) wide.

11074 Contact Wheel: 5/8" (16mm) diameter x 1/8" (3mm) wide, rubber.

**11239 Heavy-Duty Steel** 45 PSI maximum (3.1 Bars). • Grind in narrow areas.

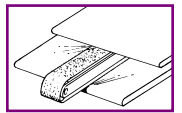

11027 Platen: 1/2" (13mm) wide. Belt Size: 1/2" (13mm) wide.

11068 Contact Wheel: 5/16" (8mm) diameter x 3/8" (9mm) wide, steel.

**11217** • Enter channels as narrow as 9/16" (14mm).

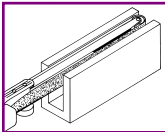

11027 Platen: 1/2" (13mm) wide. Belt Size: 1/2" (13mm) wide.

11076 Contact Wheel: 7/16" (11mm) diameter x 3/8" (9mm) wide, steel.

**11243 Heavy-Duty** • Grind over contact wheel or Dynapad®.

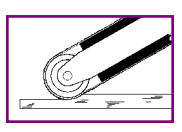

11135 Platen: 1/2" (13mm) wide. Belt Size: 1/2" (13mm) wide.

11084 Contact Wheel: 3/4" (19mm) diameter x 1/2" (13mm) wide, rubber.

**11218** • See 11228 for heavy-duty version.

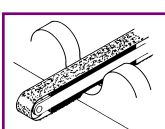

11025 Platen: 1/2" (13mm) wide. Belt Size: 1/2" (13mm) wide.

11078 Contact Wheel: 5/8" (16mm) diameter x 3/8" (9mm) wide, rubber.

**11262 "Offset Arm"** • For flat grinding using platen at or near corners and edges of large radius round. Contact wheel is offset to prevent gouging.

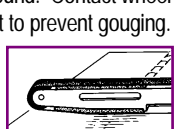
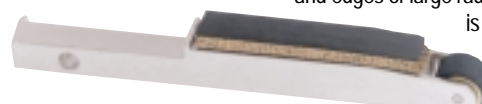

11026 Platen: 1/2" (13mm) wide. Belt Size: 1/2" (13mm) wide.

11078 Contact Wheel: 5/8" (16mm) diameter x 3/8" (9mm) wide, rubber.

# Contact Wheels & Assemblies



Wheel Dia.	Wheel Width	Bearing O.D.	Bearing I.D.	Surface Serration	Face Material	Part Number
1/4"	3/8"	3/16"	3/32"	Crowned	Steel	11333
1/4"	3/8"	3/16"	3/32"	Crowned	Steel	11332
5/16"	1/8"	1/4"	1/8"	Flat	Steel	11065
5/16"	1/8"	1/4"	1/8"	Flat	Steel	11066
5/16"	3/8"	3/16"	3/32"	Crowned	50 Duro Rubber	11343
5/16"	3/8"	3/16"	3/32"	Crowned	50 Duro Rubber	11342
5/16"	3/8"	1/4"	1/8"	Crowned	Steel	11067
5/16"	3/8"	1/4"	1/8"	Crowned	Steel	11068
5/16"	5/8"	1/4"	1/8"	Crowned	Steel	11353
5/16"	5/8"	1/4"	1/8"	Crowned	Steel	11352
7/16"	1/8"	3/8"	1/8"	Crowned	Brass	11071
7/16"	1/8"	3/8"	1/8"	Crowned	Brass	11072
7/16"	3/8"	1/4"	1/8"	Crowned	40 Duro Rubber	11363
7/16"	3/8"	1/4"	1/8"	Crowned	40 Duro Rubber	11364
7/16"	3/8"	1/4"	1/8"	Crowned	70 Duro Rubber	11069
7/16"	3/8"	1/4"	1/8"	Crowned	70 Duro Rubber	11070
7/16"	3/8"	3/8"	1/8"	Crowned	Steel	11075
7/16"	3/8"	3/8"	1/8"	Crowned	Steel	11076
* 5/8"	1/8"	3/8"	1/8"	Crowned	70 Duro Rubber	11073
* 5/8"	1/8"	3/8"	1/8"	Crowned	70 Duro Rubber	11074
* 5/8"	3/8"	3/8"	1/8"	Crowned	70 Duro Rubber	11077
* 5/8"	3/8"	3/8"	1/8"	Crowned	70 Duro Rubber	11078
5/8"	3/8"	3/8"	1/8"	Crowned	70 Duro Rubber	42653
3/4"	1/2"	3/8"	1/8"	Crowned	70 Duro Rubber	11083
3/4"	1/2"	3/8"	1/8"	Crowned	70 Duro Rubber	11084
3/4"	5/8"	3/8"	1/8"	Crowned	70 Duro Rubber	11281
3/4"	5/8"	3/8"	1/8"	Crowned	70 Duro Rubber	11282
3/4"	5/8"	3/8"	1/8"	Crowned	70 Duro Rubber	42652
3/4"	1"	3/8"	1/8"	Crowned	70 Duro Urethane	14233
3/4"	1"	3/8"	1/8"	Crowned	70 Duro Urethane	14250
1"	3/8"	3/8"	1/8"	Round Radiused	70 Duro Rubber	11079
1"	3/8"	3/8"	1/8"	Round Radiused	70 Duro Rubber	11080
1"	3/8"	3/8"	1/8"	Round Radiused	70 Duro Rubber	42654
1"	3/8"	3/8"	1/8"	"V" Shape	90 Duro Urethane	11085
1"	3/8"	3/8"	1/8"	"V" Shape	90 Duro Urethane	11086
1"	1"	5/8"	1/4"	Flat	80 Duro Rubber	11615
1"	1"	5/8"	1/4"	Flat	80 Duro Rubber	11616
1"	1"	5/8"	1/4"	Crowned	70 Duro Urethane	14234
1"	1"	5/8"	1/4"	Crowned	70 Duro Urethane	14251

\*5/8" dia. x 1/4" wide, 70 durometer rubber wheel available.

Shaded areas indicate Wheel Assembly, with bearing and shaft.

Unshaded items indicate individual contact wheel only.

### Inch to Millimeter Conversions

3/32" = 2.4 mm	5/16" = 8 mm	5/8" = 16 mm	1-1/4" = 32 mm	4" = 102 mm
1/8" = 3 mm	3/8" = 9 mm	3/4" = 19 mm	1-1/2" = 38 mm	
3/16" = 5 mm	7/16" = 11 mm	1" = 25 mm	1-3/4" = 44 mm	
1/4" = 6 mm	1/2" = 13 mm	1-1/8" = 29 mm	2" = 51 mm	

Wheel Dia.	Wheel Width	Wheel O.D.	Wheel I.D.	Bearing O.D.	Bearing I.D.	Surface Serration	Face Material	Part Number
1-1/4"	1"	5/8"	1/4"	5/8"	1/4"	Crowned	70 Duro Urethane	14235
1-1/4"	1"	5/8"	1/4"	5/8"	1/4"	Crowned	70 Duro Urethane	14252
1-1/2"	1"	5/8"	1/4"	5/8"	1/4"	Crowned	70 Duro Urethane	14236
1-1/2"	1"	5/8"	1/4"	5/8"	1/4"	Crowned	70 Duro Urethane	14253
1-3/4"	1"	5/8"	1/4"	5/8"	1/4"	Crowned	70 Duro Urethane	14237
1-3/4"	1"	5/8"	1/4"	5/8"	1/4"	Crowned	70 Duro Urethane	14254
2"	1/2"	5/8"	1/4"	5/8"	1/4"	Standard	90 Duro Urethane	11643
2"	1/2"	5/8"	1/4"	5/8"	1/4"	Standard	90 Duro Urethane	11644
2"	1/2"	5/8"	1/4"	5/8"	1/4"	Scoop	90 Duro Urethane	11645
2"	1/2"	5/8"	1/4"	5/8"	1/4"	Scoop	90 Duro Urethane	11646
2"	1"	5/8"	1/4"	5/8"	1/4"	Standard	60 Duro Urethane	11647
2"	1"	5/8"	1/4"	5/8"	1/4"	Standard	60 Duro Urethane	11648
2"	1"	5/8"	1/4"	5/8"	1/4"	Crowned	70 Duro Urethane	14238
2"	1"	5/8"	1/4"	5/8"	1/4"	Crowned	70 Duro Urethane	14255
2"	1"	5/8"	1/4"	5/8"	1/4"	Crowned	40 Duro Rubber	11633
2"	1"	5/8"	1/4"	5/8"	1/4"	Crowned	40 Duro Rubber	11634
2"	1"	5/8"	1/4"	5/8"	1/4"	Crowned	70 Duro Rubber	11778
2"	1"	5/8"	1/4"	5/8"	1/4"	Crowned	70 Duro Rubber	11798
2"	1"	5/8"	1/4"	5/8"	1/4"	Crowned	80 Duro Rubber	11799
2"	1"	5/8"	1/4"	5/8"	1/4"	Standard	70 Duro Urethane	11649
2"	1"	5/8"	1/4"	5/8"	1/4"	Standard	70 Duro Urethane	11650
2"	1"	5/8"	1/4"	5/8"	1/4"	Standard	70 Duro Urethane	14256
2"	1"	5/8"	1/4"	5/8"	1/4"	Scoop	70 Duro Urethane	11780
2"	1"	5/8"	1/4"	5/8"	1/4"	Standard	80 Duro Urethane	11651
2"	1"	5/8"	1/4"	5/8"	1/4"	Standard	80 Duro Urethane	11652
2"	1"	5/8"	1/4"	5/8"	1/4"	Standard	90 Duro Urethane	11617
2"	1"	5/8"	1/4"	5/8"	1/4"	Standard	90 Duro Urethane	11618
2"	1"	5/8"	1/4"	5/8"	1/4"	Standard	90 Duro Urethane	11623
2"	1"	5/8"	1/4"	5/8"	1/4"	Scoop	90 Duro Urethane	11613
2"	1"	5/8"	1/4"	5/8"	1/4"	Scoop	90 Duro Urethane	11614
2"	2"	1-1/8"	1/2"	1-1/8"	1/2"	Standard	70 Duro Urethane	11846
2"	2"	1-1/8"	1/2"	1-1/8"	1/2"	Standard	70 Duro Urethane	11847
2"	2"	1-1/8"	1/2"	1-1/8"	1/2"	Standard	90 Duro Urethane	11850
2"	2"	1-1/8"	1/2"	1-1/8"	1/2"	Standard	90 Duro Urethane	11851
4"	1/2"	5/8"	1/4"	5/8"	1/4"	Severely Radiused	70 Duro Rubber	11637
4"	1/2"	5/8"	1/4"	5/8"	1/4"	Severely Radiused	70 Duro Rubber	11638
4"	5/8"	5/8"	1/4"	5/8"	1/4"	Scoop	40 Duro Rubber	11641
4"	5/8"	5/8"	1/4"	5/8"	1/4"	Scoop	40 Duro Rubber	11642
4"	5/8"	5/8"	1/4"	5/8"	1/4"	Scoop	60 Duro Urethane	11884
4"	5/8"	5/8"	1/4"	5/8"	1/4"	Scoop	80 Duro Urethane	11886
4"	5/8"	5/8"	1/4"	5/8"	1/4"	Scoop	90 Duro Urethane	11888
4"	5/8"	5/8"	1/4"	5/8"	1/4"	Scoop	90 Duro Urethane	11889
4"	1"	5/8"	1/4"	5/8"	1/4"	Crowned	40 Duro Rubber	11619
4"	1"	5/8"	1/4"	5/8"	1/4"	Crowned	40 Duro Rubber	11620
4"	1"	5/8"	1/4"	5/8"	1/4"	Scoop	60 Duro Urethane	11688
4"	1"	5/8"	1/4"	5/8"	1/4"	Scoop	60 Duro Urethane	11689
4"	1"	5/8"	1/4"	5/8"	1/4"	Scoop	80 Duro Urethane	11635
4"	1"	5/8"	1/4"	5/8"	1/4"	Scoop	80 Duro Urethane	11636
4"	2"	5/8"	1/4"	5/8"	1/4"	Scoop	80 Duro Urethane	11876



# Dynapad® Platen Pads

*Provides abrasive belt support on all Dynabelter and Dynafile series contact arms.*

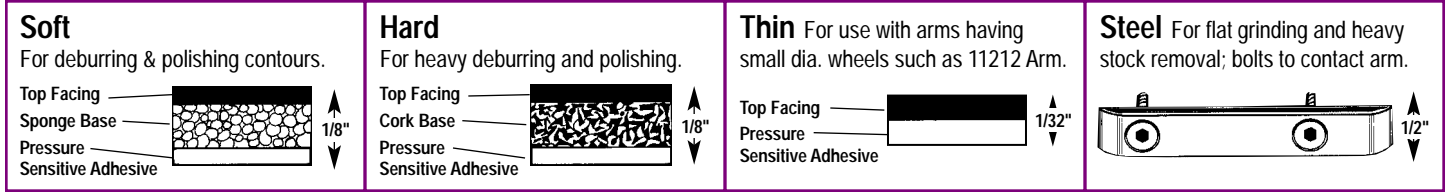

Part Number	Contact Arm Used On	Platen Size - Inch (mm) Width x Length x Thickness	Platen Material	Pkg. Qty.
11024	Dynafile	1/2" (13) x 3" (89) bolts on	Steel	1
11025	Dynafile	1/2" (13) x 7" (178) x 1/8" (3)	Soft/Sponge	5
11026	Dynafile	1/2" (13) x 7" (178) x 1/8" (3)	Hard/Cork	5
11027	Dynafile	1/2" (13) x 7" (178) x 1/32" (.8)	Thin	5
11028	Dynafile (11228 Arm)	1/2" (13) x 3" (89) bolts on	Steel	1
11032	Dynafile	1/4" (6) x 7" (178) x 1/8" (3)	Soft/Sponge	5

Part Number	Contact Arm Used On	Platen Size - Inch (mm) Width x Length x Thickness	Platen Material	Pkg. Qty.
11034	Dynafile	1/4" (6) x 7" (178) x 1/32" (.8)	Thin	5
11604	Dynabelter	1" (25) x 7" (178) x 1/8" (3)	Soft/Sponge	5
11605	Dynabelter	1" (25) x 7" (178) x 1/8" (3)	Hard/Cork	5
11814	Dynabelter	2" (51) x 7" (178) x 1/8" (3)	Hard/Cork	1
11834	Dynabelter	2" (51) x 7" (178) x 1/8" (3)	Soft/Sponge	1

Note: Dynapad Platen Pads are PSA mounted and easily trimmed to size.  
 Exceptions: 11024 and 11028 Steel Platens bolt on. Unit = 10 packages each.

## Dynamount Bench Mount/Foot Pedal & Hose Assembly



### 80015 Foot Pedal & Hose Assembly

- Connects to bench-mounted air tool; provides on/off control of air tool operation.
- Has 11291 Foot Pedal and 11292 Hose Assembly 8 ft. (2.44 m). 3/8" (9mm) I. D. x 1 1/16" (17.5 mm) O. D., 1/4" NPT male fitting.

### Model 80022

- Designed exclusively for Dynabelter models 11475, 11476 and 11477.

### Features

- Frees operator's hands... allows total control of the workpiece.
- Tool clamp swivels 180° for set-up versatility.
- Heavy-duty, rugged construction.
- Easily mounts to workbench.
- Stands 9-3/4" (247.6 mm) tall in the upright position.
- Mounted tool can be rotated within clamp for desired positioning.



Tool not included.

### Model 80022

## Dynūba® Belt Treatments

*Cleaning and polishing products for abrasive and polishing belts.*

### Dynūba 26

Abrasive belt grease for use with all metals.

- Promotes free cutting.
- Prevents heat discoloration.
- Improves abrasive belt life.

60020: 1-1/2 lb. (.68 kg) tube.  
Unit = 12 tubes.



### Dynūba 100 *Ozone Safe!*

Our most popular Dynūba product. Keeps belts free of metal build-up when sanding non-ferrous metals with grit 80 or finer.

60000: 11.25 oz. (33.3 cl) can. Unit = 12 cans.  
 60001: 1-gal. (3.8 ltr) can. Unit = 4 cans.  
 60003: 5-gal. (18.9 ltr) can. Unit = 1 can.  
 60004: 55-gal. (208.2 ltr) drum. Unit = 1 drum.



*Extends belt life!*

### Dynūba 103

Removes abrasive belt build-up of wood and resin residue.

- Apply to grit side of moving abrasive belts and discs.
- 8-1/2" (216 mm) x 1-1/2" (38 mm) x 1-1/2" (38 mm) gum rubber stick.

60030: 1/2 lb. (.23 kg) stick.  
Unit = 12 sticks.



### Dynūba 171

For brilliant cut and color on stainless and aluminum.

- Polishing compound for cloth belts and rag wheels.
- Apply to moving cloth belts or rag wheel.
- Easily cleaned.

60035: 3 lb. (1.36 kg) tube.  
Unit = 12 tubes.



# Dynabelter® Abrasive Belts & Polishing Belts

**Coated abrasives, abrasive impregnated non-woven nylon and cloth polishing belts.**

30" (762mm) Long Coated Aluminum Oxide								
Belt	Abrasive Grit							
	36	60	80	120	180	220	320	500
1/4"	-	90466	90468	90470	90471	-	90473	-
1/2"	90501	90502	90492	90504	90493	90494	90496	90498
1"	90507	90509	90510	90511	90512	90513	90514	90516
2"	90385	90386	90387	90389	90390	90391	90392	90539

**34" (864mm) Long Coated Aluminum Oxide – Grit/Part Number — 2" (51mm) Wide:** 40/90376; 60/90377; 80/90378; 100/90379; 120/90380; 180/90381; 320/90388.

1/4" (6mm) , 1/2" (13mm) and 1" (25mm) Wide Belts: Unit = 200 Belts. 2" (51mm) Wide Belts: Unit = 50 Belts.

30" (762mm) Long Coated Alumina Zirconia							
Belt Width	Abrasive Grit			Belt Width	Abrasive Grit		
	36	60	80		36	60	80
1/2"	90500	90503	90505	2"	90520	90523	90524
1"	90506	90508	90518				

30" (762mm) Long Ceramic Coated Aluminum Oxide								
Belt Width	Abrasive Grit			Belt Width	Abrasive Grit			
	36	60	80		36	60	80	
1/4"	91129	91130	91131	1"	91146	91147	91148	
1/2"	91137	91138	91139	2"	91155	91156	91157	

1/4" (6mm), 1/2" (13mm) and 1" (25mm) Wide Belts: Unit = 200 Belts. 2" Wide Belts: Unit = 50 Belts.

30" (762mm) Long Non-Woven Nylon — Unit = 10 Belts			
Belt	Grade/Belt Color		
	Super Fine/Grey Grit Range 320-600	Very Fine/Blue Grit Range 220-320	Medium/Maroon Grit Range 150-180
1/2"	90406	90436	90442
1"	90401	90437	90444
2"	90414	90438	90448

2" (51mm) Wide x 34" (864mm) Long Non-Woven Nylon — Unit = 10 Belts		
Very Fine/Blue Grit Range 220-320	Medium/Maroon Grit Range 150-180	Coarse/Brown Grit Range 80-150
90371	90373	90374

**1" (51mm) Wide x 30" (762mm) Long Cloth Polishing Belt**  
Part Number 90015. Unit = 25 Belts. Other sizes available upon request.

## Motor Tune-Up Kits & Gear Lubricant

**Keep your Dynabelter in tip-top shape!**



- Kits contain bearings, O rings, washers, seals and filters necessary to rebuild your Dynabelter motor.

Model	Kit No.
11450, 11477	96259
11462, 11475, 11480	96045
11476, 11481, 11486, 11489	96011



**Grease Gun and Lubrication Grease**

**95541:** Push-type Grease Gun (one-hand operation).

**95542:** 10 oz. (283.5 g) tube.

- Multi-purpose grease for all types of bearings, cams and gears.
- High film strength; excellent resistance to water, steam, etc. Workable range 0° F to 300° F (0°C to 149° C).



## Dynabrade Air Lube

**Air line lubrication products for better tool performance and to help prevent downtime.**



**Dynabrade Air Lube (10W/NR) 95821:** 4 oz. (118 ml). **95842:** 1 pt. (473 ml). **95843:** 1 gal. (3.8 l).

- Formulated for pneumatic equipment.
- Absorbs up to 10% of its weight in water.
- Prevents rust and formation of gum/sludge for longer tool operation with greater power and less downtime.

**Important:** General air tool maintenance begins with motor lubrication. Filter-lubricators are also necessary for greater performance and increased life of air tools. **Dynabrade recommends one drop of Air Lube per minute for each 10 SCFM (283 LPM) of air flow (example: drop rate at 4 drops per minute if tool is rated at 40 SCFM - 1133 LPM).** Dynabrade tools must be used with filter-lubricators to maintain all warranties.

# Dynabrade Filter-Regulator-Lubricator

**Our Filter-Regulator-Lubricator is a cost effective solution for air supply & vacuum/exhaust systems.**

**11405:** 40 CFM (1,133 LPM) @ 100 PSI (6.9 Bars), 3/8" NPT female ports.

**11411:** Up to 100 CFM (2,832 LPM) @ 100 PSI (6.9 Bars), 1/2" NPT female ports.

- Provides accurate air pressure regulation, two stage filtration of water/contaminants and lubrication of pneumatic components. Maximum 150 PSI (10.3 Bars) @ 140° F (60° C) for both models.

**Important:** General air tool maintenance begins with motor lubrication. Filter-Regulator- Lubricators (FRL) are also necessary for greater performance and increased life of air tools. **Dynabrade recommends one drop of Air Lube per minute for each 10 SCFM (283 LPM) of air flow (example: drop rate at 4 drops per minute if tool is rated at 40 SCFM - 1133 LPM).** Always mount FRL units as close to the tool as possible. Always mount lubricator higher than the tool or at least the same height. Use one lubricator per tool. Using more than one tool per lubricator may result in one tool receiving lubrication and the others running dry, leading to premature failure. **Dynabrade tools must be used with FRL units to maintain all warranties.**



**New Modular Design Allows For Customization and Versatility!**

## Dynaswivel® Air Line Connector

**New Model 94300 Composite Dynaswivel®. Improved air flow of up to 33 CFM (935 LPM).**

### Features

- Patented "universal-joint" connects portable air tools to an air line.
- Swivels 360° AT TWO PIVOT POINTS allowing the air hose to drop directly to the floor while providing superb tool handling.
- New lightweight, non-marring composite construction; industrial quality.
- 96177 Dynaswivel Display Pak available. Includes countertop-type display box and ten 94300 Dynaswivel Air-Line Connectors.

### Original Dynaswivel® Air Line Connectors

For use with most air tools...grinders, sanders, glue guns, staple guns, drills, buffers, etc. The Dynaswivel is a "universal-joint" that connects portable air tools to an air line. The Dynaswivel improves maneuverability, minimizes operator fatigue and extends hose life.

#### 95461 & 95462 Original Dynaswivel For 3/8" NPT and 1/2" NPT Tools

- SWIVELS 360° AT TWO LOCATIONS which allows air hose to drop straight to the floor, no matter how the tool is held.

#### 95852 – 1/8" NPT "Small Tool" Dynaswivel

- SWIVELS 360° AT TWO LOCATIONS. Our newest model, ideal for light production and assembly line operations. Fitting has 1/4" NPT female thread for air line connection and 1/8" NPT male thread to fit small tools such as pneumatic screw drivers.

#### 95734 – 1/4" NPT Flow Control Dynaswivel

- SWIVELS 360° AT TWO LOCATIONS. Our original Dynaswivel plus finger-tip air-flow control dial.

#### 95590, 95591 & 95592 Single-Pivot Swivel For 1/4" NPT, 3/8" NPT and 1/2" NPT Tools

- Right angle "single-pivot" swivels 360° at one location.
- Designed to permit air hose to extend horizontally away from tool.

#### 95690 – 3/4" NPT Dynaswivel

- SWIVELS 360° AT TWO LOCATIONS. For air flow above 65 CFM (1,841 LPM) .



**New Dynaswivel 94300 – 1/4" NPT**



Patent No.  
D-295,552;  
D-295,553;  
D-317,818.

**Original Dynaswivel 95461 – 3/8" NPT 95462 – 1/2" NPT**

**95852 – 1/8" x 1/4" NPT "Small Tool" Dynaswivel**

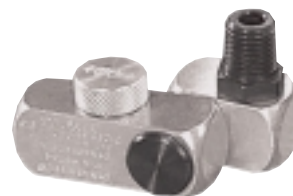

**95734 – 1/4" NPT Flow Control Dynaswivel**

**95590 – 1/4" NPT Single-Pivot Dynaswivel**



**95690 3/4" NPT Dynaswivel**



Part Number	Thread Size	Weight Pound (kg)	Air Flow Range CFM (LPM)	Unit Qty.
95461	3/8" NPT	0.4 (.18)	26 (736) to 45 (1,274)	18 ea.
95462	1/2" NPT	0.8 (.36)	46 (1,303) to 65 (1,841)	6 ea.
95590	1/4" NPT	0.12 (.054)	Up to 25 (708)	32 ea.
95591	3/8" NPT	0.26 (.12)	26 (736) to 45 (1,274)	22 ea.
95592	1/2" NPT	0.47 (.21)	46 (1,303) to 65 (1,841)	12 ea.
95690	3/4" NPT	1.5 (.68)	Above 65 (1,841)	6 ea.
95734	1/4" NPT	0.25 (.11)	Up to 25 (708)	24 ea.
95852	1/8" x 1/4" NPT	0.19 (.086)	Up to 25 (708)	24 ea.





**Important:** All models 150 PSI max. Do not use on percussion tools or areas of high mechanical abuse. Do not exceed recommended torque value of 20' lbs. (28-30 nm).

# Swivel Air Line Hoses & Fittings



- Eliminates kinking.
- Tough, flexible and lightweight.

1/4" (6 mm) and 3/8" (9 mm) Diameter Swivel Hoses			
Hose Dia.	Length	Description	Part Number
1/4" (6 mm)	3 ft. (.92m)	1/4" female to 1/4" male	96217
		1/4" female to 1/8" male	96218
	6 ft. (1.8m)	1/4" female to 1/4" male	96219
		1/4" female to 1/8" male	96220
	Custom	Hose by the foot (no fittings). Order fittings separately, if desired,	96221
3/8" (9 mm)	3 ft. (.92m)	1/4" female to 1/4" male	96222
	6 ft. (1.8m)	1/4" female to 1/4" male	96223
	Custom	Hose by the foot (no fittings). Order fittings separately, if desired,	96224

Swivel Fittings For 1/4" and 3/8" Diameter Swivel Hoses							
For 1/4" Hose		1/4" NPT female	96225	For 3/8" Hose		1/4" NPT female	96228
		1/4" NPT male	96226			1/4" NPT male	96229
		1/8" NPT male	96227				

# Flexible Air Line Assemblies

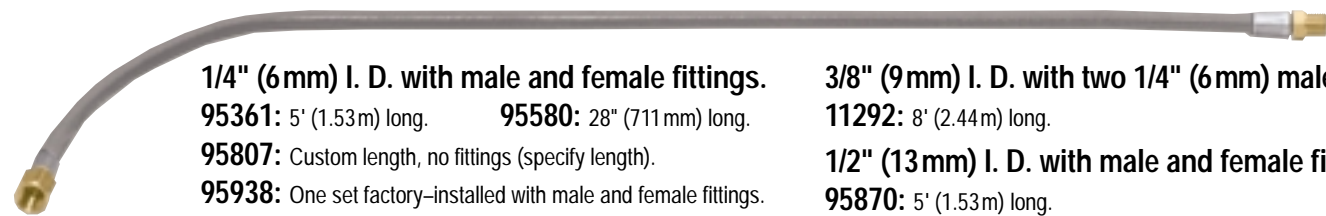

**1/4" (6 mm) I. D. with male and female fittings.**  
**95361:** 5' (1.53m) long.      **95580:** 28" (711 mm) long.  
**95807:** Custom length, no fittings (specify length).  
**95938:** One set factory-installed with male and female fittings.

**3/8" (9 mm) I. D. with two 1/4" (6 mm) male fittings.**  
**11292:** 8' (2.44 m) long.  
**1/2" (13 mm) I. D. with male and female fittings.**  
**95870:** 5' (1.53 m) long.

**Visit our new Web Site:**

Address

*Our site is designed to provide technical information worldwide. With a host of user-friendly menus, you will now be able to...*

- Browse our catalog.
- Search tools by applications.
- Download parts pages.
- Contact our factory sales reps.
- Get up-to-date trade show schedules including our booth number.
- Contact our customer service dept.
- And much more!



**95671 Dynabelter  
Instructional Video**

- Features techniques for getting the best results.
- VHS format. Also available in PAL format, please specify.

**DISTRIBUTED BY:**

E-Mail: [customer.service@dynabrade.com](mailto:customer.service@dynabrade.com)

DYNABRADE, INC., 8989 Sheridan Drive • Clarence, NY 14031-1490 • Phone: (716) 631-0100 • Fax: 716-631-2073 • International Fax: 716-631-2524  
 DYNABRADE EUROPE S.à.r.l., Zone Artisanale • L-5485 Wormeldange—Haut, Luxembourg • Telephone: 352 76 84 94 • Fax: 352 76 84 95

©DYNABRADE, INC., 1998



PRINTED IN USA