

User Manual

Revision 3.001
English

M-Bus Master / Modbus Slave - Converter

(Order Code: HD67029-B2-232-20, HD67029-B2-232-40, HD67029-B2-232-80, HD67029-B2-232-160, HD67029-B2-232-250, HD67029-B2-485-20, HD67029-B2-485-40, HD67029-B2-485-80, HD67029-B2-485-160, HD67029-B2-485-250)

For Website information:

www.adfweb.com?Product=HD67029

For Price information:

www.adfweb.com?Price=HD67029-B2-232-20
www.adfweb.com?Price=HD67029-B2-232-40
www.adfweb.com?Price=HD67029-B2-232-80
www.adfweb.com?Price=HD67029-B2-232-160
www.adfweb.com?Price=HD67029-B2-232-250
www.adfweb.com?Price=HD67029-B2-485-20
www.adfweb.com?Price=HD67029-B2-485-40
www.adfweb.com?Price=HD67029-B2-485-80
www.adfweb.com?Price=HD67029-B2-485-160
www.adfweb.com?Price=HD67029-B2-485-250

Benefits and Main Features:

- ✦ Very easy to configure
- ✦ Electrical isolation
- ✦ Temperature range: -40°C/85°C (-40°F/185°F)



For others M-Bus products see also the following link:

**Converter M-Bus Wireless to
(Modbus TCP Slave)**
www.adfweb.com?Product=HD67083
www.adfweb.com?Product=HD67084 **(Ethernet)**

**Converter M-Bus to
(RS232) (RS485)**
www.adfweb.com?Product=HD67021
www.adfweb.com?Product=HD67022

Analyzer / Scanner / Sniffer M-Bus
www.adfweb.com?Product=HD67031

Isolator/Repeater M-Bus
www.adfweb.com?Product=HD67032M

Gateway M-Bus / Modbus TCP
www.adfweb.com?Product=HD67044

Gateway M-Bus / PROFIBUS
www.adfweb.com?Product=HD67053M

Gateway M-Bus Concentrator
www.adfweb.com?Product=HD67054M

Gateway M-Bus Slave / Modbus RTU master
www.adfweb.com?Product=HD67059M-232

Do you have an your customer protocol?
www.adfweb.com?Product=HD67003

Do you need to choose a device? do you want help?
www.adfweb.com?Cmd=helpme



User Manual

INDEX:

	Page
INDEX	2
UPDATED DOCUMENTATION	2
REVISION LIST	2
WARNING	2
TRADEMARKS	2
SECURITY ALERT	3
EXAMPLE OF CONNECTION	4
CONNECTION SCHEME	5
CHARACTERISTICS	7
CONFIGURATION	7
POWER SUPPLY	8
FUNCTION MODES	9
LEDS	10
RS232	11
RS485	12
M-BUS	13
ETHERNET	13
USE OF COMPOSITOR SW67029	14
NEW CONFIGURATION / OPEN CONFIGURATION	15
SOFTWARE OPTIONS	16
SET COMMUNICATION	17
M-BUS	19
MANUFACTURER SPECIFIC DATA	33
UPDATE DEVICE	34
SCAN & DECODE	38
MECHANICAL DIMENSIONS	39
ORDERING INFORMATIONS	40
ACCESSORIES	41
DISCLAIMER	42
OTHER REGULATIONS AND STANDARDS	42
WARRANTIES AND TECHNICAL SUPPORT	43
RETURN POLICY	43

UPDATED DOCUMENTATION:

Dear customer, we thank you for your attention and we remind you that you need to check that the following document is:

- ✚ Updated
- ✚ Related to the product you own

To obtain the most recently updated document, note the “document code” that appears at the top right-hand corner of each page of this document.

With this “Document Code” go to web page www.adfweb.com/download/ and search for the corresponding code on the page. Click on the proper “Document Code” and download the updates.

REVISION LIST:

Revision	Date	Author	Chapter	Description
2.053	04/03/2013	Nt	All	Added new chapters
2.054	12/12/2013	Ff	All	Revision
3.000	15/12/2017	Ff	All	New hardware version
3.001	03/07/2018	Ff	All	Revision

WARNING:

ADFweb.com reserves the right to change information in this manual about our product without warning. ADFweb.com is not responsible for any error this manual may contain.

TRADEMARKS:

All trademarks mentioned in this document belong to their respective owners.

SECURITY ALERT:**GENERAL INFORMATION**

To ensure safe operation, the device must be operated according to the instructions in the manual. When using the device, legal and safety regulation are required for each individual application. The same applies also when using accessories.

INTENDED USE

Machines and systems must be designed so the faulty conditions do not lead to a dangerous situation for the operator (i.e. independent limit switches, mechanical interlocks, etc.).

QUALIFIED PERSONNEL

The device can be used only by qualified personnel, strictly in accordance with the specifications. Qualified personnel are persons who are familiar with the installation, assembly, commissioning and operation of this equipment and who have appropriate qualifications for their job.

RESIDUAL RISKS

The device is state-of-the-art and is safe. The instruments can represent a potential hazard if they are inappropriately installed and operated by untrained personnel. These instructions refer to residual risks with the following symbol:



This symbol indicates that non-observance of the safety instructions is a danger for people that could lead to serious injury or death and / or the possibility of damage.

CE CONFORMITY

The declaration is made by our company. You can send an email to support@adfweb.com or give us a call if you need it.

EXAMPLE OF CONNECTION:

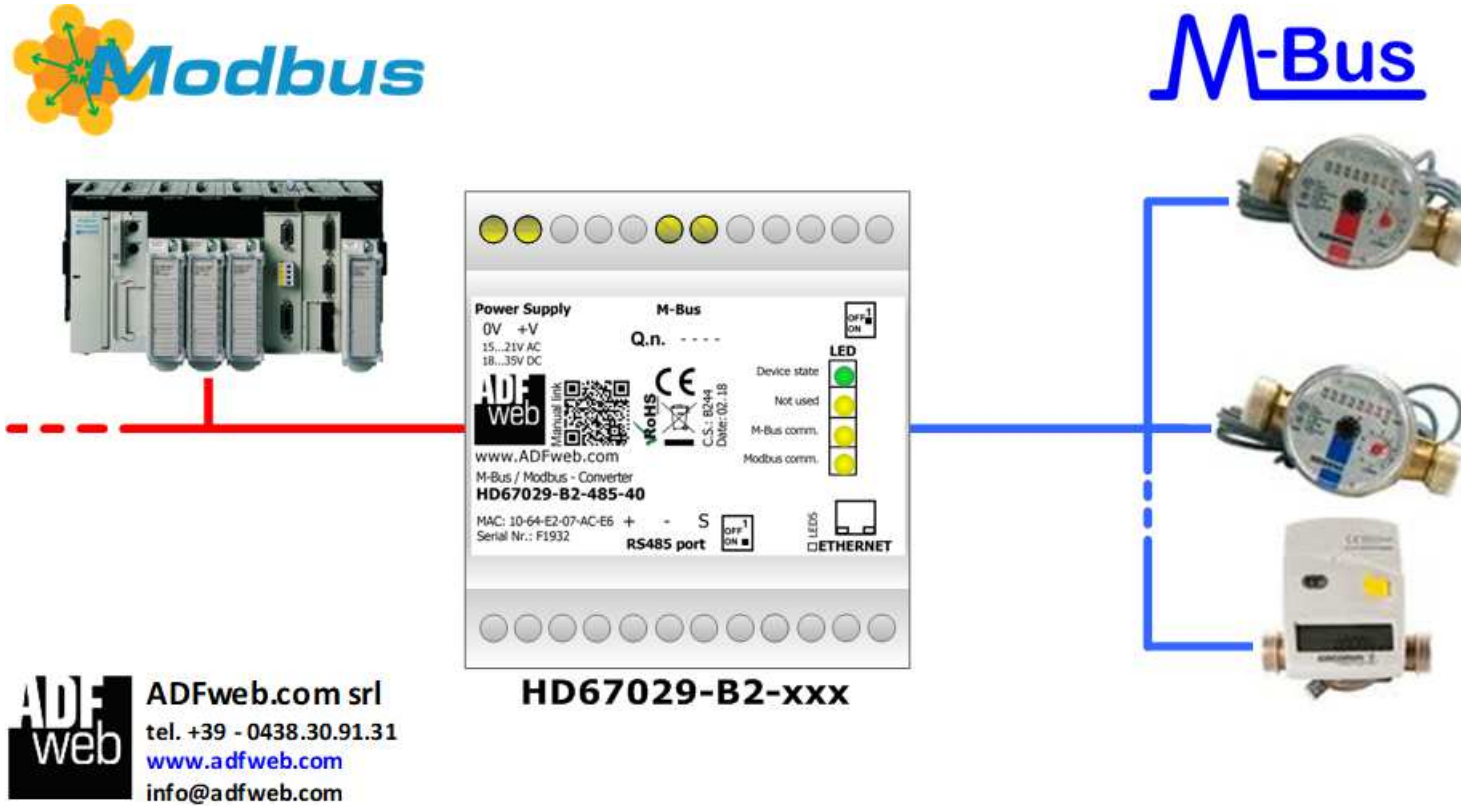

ADFweb ADFweb.com srl
 tel. +39 - 0438.30.91.31
www.adfweb.com
info@adfweb.com

HD67029-B2-xxx

CONNECTION SCHEME:

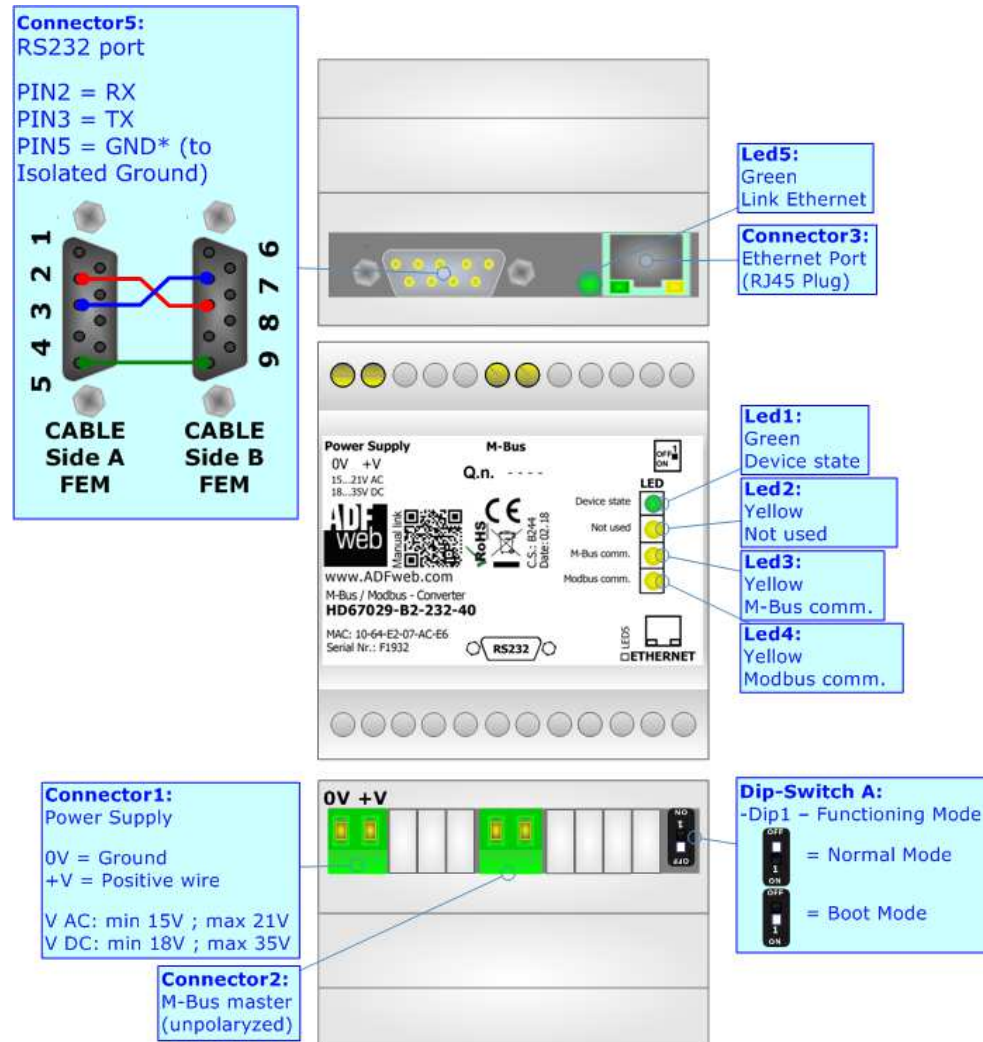

Figure 1a: Connection scheme for HD67029-B2-232-xxx

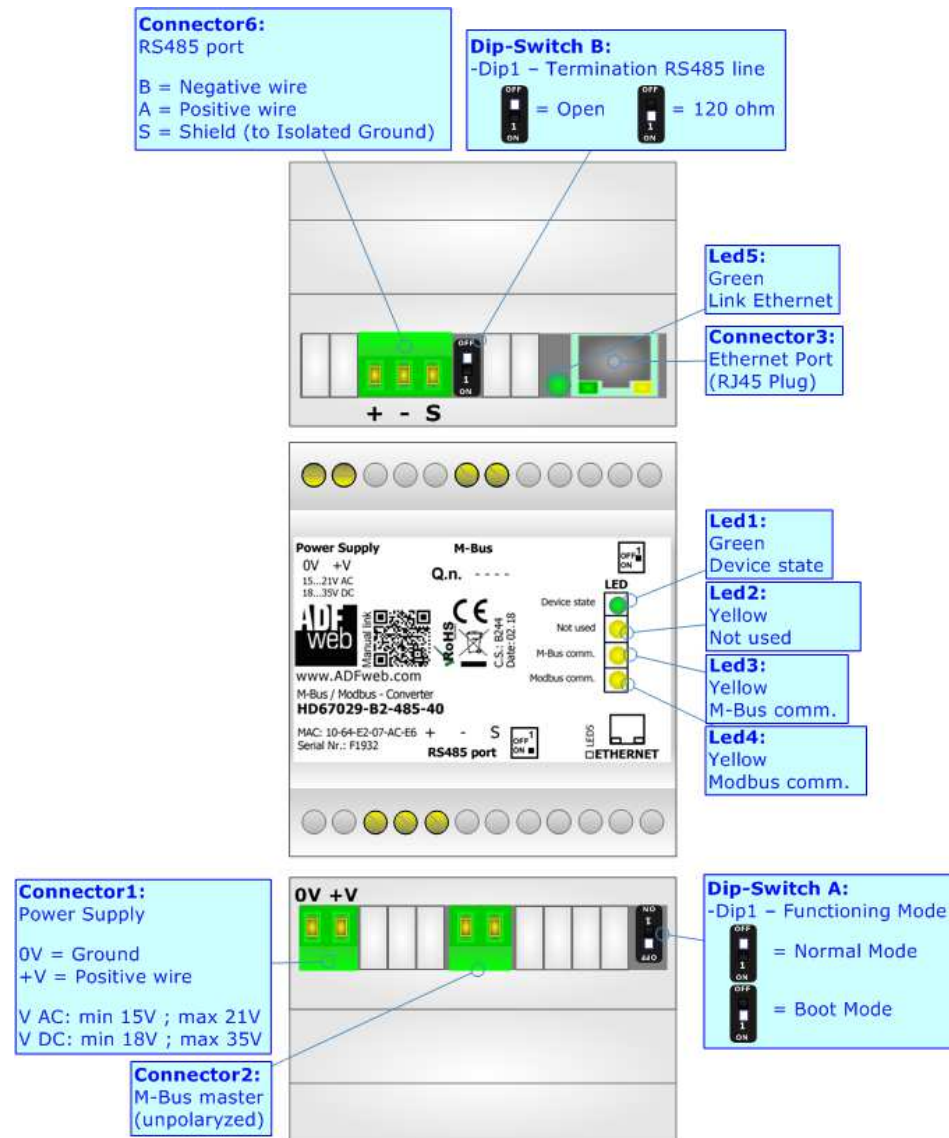

Figure 1b: Connection scheme for HD67029-B2-485-xxx

CHARACTERISTICS:

The HD67029 is a M-Bus master to Modbus slave Converter.

It allows the following characteristics:

- Electrical isolation between RS232/RS485 - M-Bus – Power Supply;
- Baud Rate and Parity changeable with software;
- Mountable on 35mm Rail DIN;
- Wide power supply input range: 15...21V AC or 18...35V DC;
- Wide temperature range: -40°C / 85°C [-40°F / +185°F].

At the Converter can be connected up to 250 standard M-Bus devices. This number depends of the code expressed by the xxx number:

- HD67029-B2-232-20 or HD67029-B2-485-20 support up to 20 M-Bus devices;
- HD67029-B2-232-40 or HD67029-B2-485-40 support up to 40 M-Bus devices;
- HD67029-B2-232-80 or HD67029-B2-485-80 support up to 80 M-Bus devices;
- HD67029-B2-232-160 or HD67029-B2-485-160 support up to 160 M-Bus devices;
- HD67029-B2-232-250 or HD67029-B2-485-250 support up to 250 M-Bus devices.

 In the case of HD67029-B2-xxx-160 the device must be mounted on 35mm DIN rail which is horizontally mounted on a wall or cabinet back-plate. To avoid obstructions to the airflow around the unit it is recommended to not cover the paths of air.

 In the case of HD67029-B2-xxx-250 the device must be mounted on 35mm DIN rail which is horizontally mounted on a wall or cabinet back-plate. These units have a fan in the top of the enclosure. To avoid obstructions to the airflow around the unit it is recommended to not cover the paths of air. Take care to not cover the fan. It is recommended to put the device into a ventilated cabinet.

CONFIGURATION:

You need Compositor SW67029 software on your PC in order to perform the following:

- Define the parameter of Modbus and M-Bus line;
- Define which M-Bus variables are readable on Modbus ;
- Update the device.

POWER SUPPLY:

The devices can be powered at 15...21V AC and 18...35V DC. The consumption depends to the code of the device. For more details see the two tables below.

VAC		VDC	
Vmin	Vmax	Vmin	Vmax
15V	21V	18V	35V

Consumption at 24V DC:

Device	No Load [W/VA]	Full Load [W/VA]*
HD67029-B2-xxx-20	3.5	4
HD67029-B2-xxx-40		5
HD67029-B2-xxx-80		8
HD67029-B2-xxx-160		14
HD67029-B2-xxx-250		30

* This value is with all the Slave M-Bus devices of the code (20, 40, 80, 160, 250) connected to the line

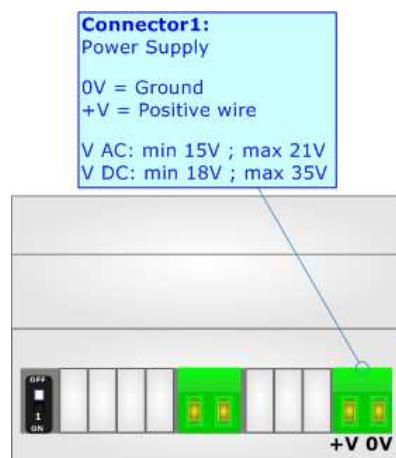

Warning: Not reverse the polarity power

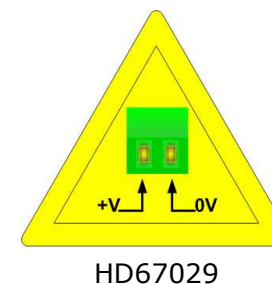

FUNCTION MODES:

The device has got two functions mode depending of the position of the Dip1 of 'Dip-Switch A' of HD67029-B2-xxx-xxx:

- The first, with Dip1 of 'Dip-Switch A' at OFF position, is used for the normal working of the device.
- The second, with Dip1 of 'Dip-Switch A' at ON position, is used for uploading the Project and/or Firmware.

For the operations to follow for the updating, see 'UPDATE DEVICE' section.

According to the functioning mode, the LEDs will have specifics functions, see 'LEDS' section.

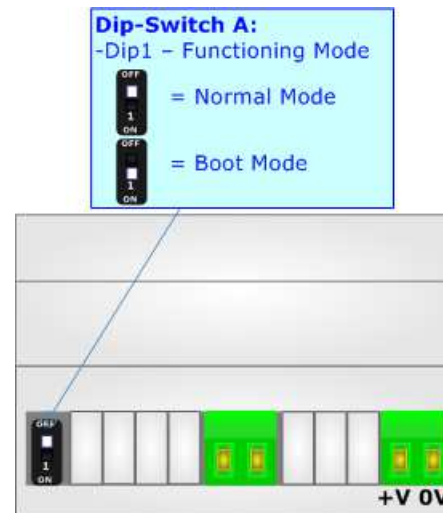

LEDS:

The device has got five LEDs that are used to give information of the functioning status.
The various meanings of the LEDs are described in the table below.

LED	Normal Mode	Boot Mode
1: Device state (green)	Blinks slowly (~1Hz)	Blinks quickly: Boot state Blinks very slowly (~0.5Hz): update in progress
2: Not used	OFF	Blinks quickly: Boot state Blinks very slowly (~0.5Hz): update in progress
3: M-Bus Comm.	Blinks when a M-Bus response is received	Blinks quickly: Boot state Blinks very slowly (~0.5Hz): update in progress
4: Modbus comm. (green)	Blinks when a Modbus request is received	Blinks quickly: Boot state Blinks very slowly (~0.5Hz): update in progress
5: Ethernet Link	ON: Ethernet cable connected OFF: Ethernet cable disconnected	ON: Ethernet cable connected OFF: Ethernet cable disconnected

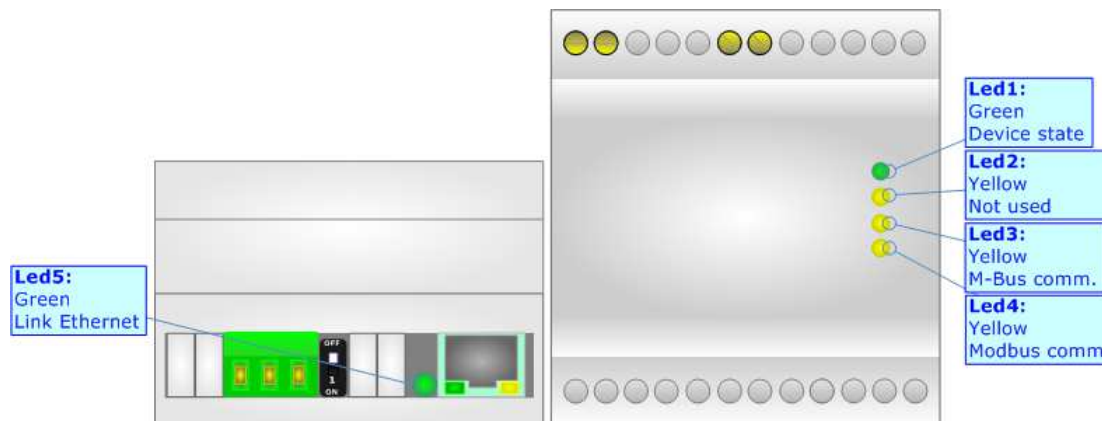

RS232:

The connection from RS232 socket to a serial port (example one from a personal computer) must be made with a Null Modem cable (a serial cable where the pins 2 and 3 are crossed).

It is recommended that the RS232 cable not exceed 15 meters.

The HD67029 is provided with a D-sub connector type DE-9 Male (also called DB-9). The cable must use a DE-9 Female connector.

The serial port is used for programming the device (HD67029M-xxx-20) and for Modbus communication.

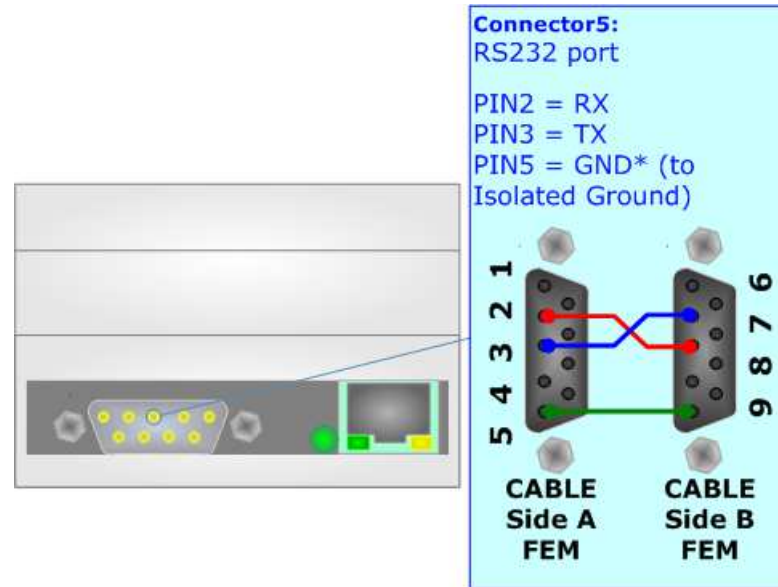

RS485:

To terminate the RS485 line with a 120Ω resistor, it is necessary to put dip 1 ON, like in figure.

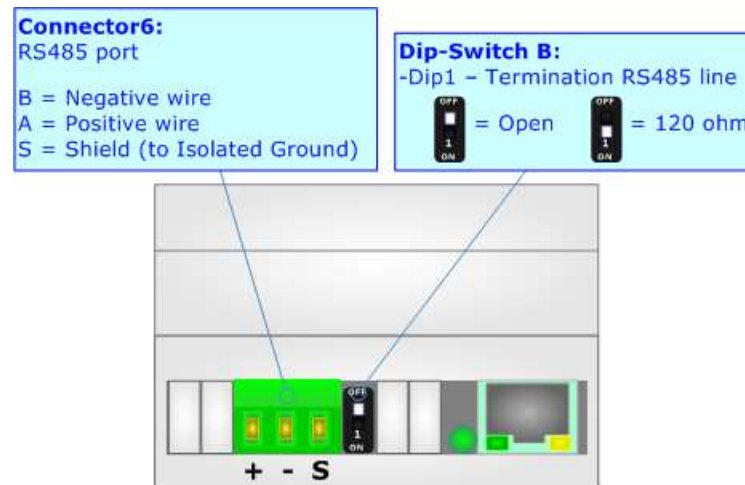

The maximum length of the cable should be 1200m (4000 feet).

Here some codes of cables:

- Belden: p/n 8132 - 2x 28AWG stranded twisted pairs conductor + foil shield + braid shield;
- Belden p/n 82842 - 2x 24AWG stranded twisted pairs conductor + foil shield + braid shield;
- Tasker: p/n C521 - 1x 24AWG twisted pair conductor + foil shield + braid shield;
- Tasker: p/n C522 - 2x 24AWG twisted pairs conductor + foil shield + braid shield.

M-BUS:

The M-Bus is a unpolarized bus.

A two wire standard telephone cable (JYStY N*2*0.8 mm) is used as the transmission medium for the M-Bus. The maximum distance between a slave and the repeater is 350m; this length corresponds to a cable resistance of up to 29Ω. This distance applies for the standard configuration having Baud rates between 300 and 9600 Baud, and a maximum of 250 slaves. The maximum distance can be increased by limiting the Baud rate and using fewer slaves, but the bus voltage in the space state must at no point in a segment fall below 12V, because of the remote powering of the slaves. In the standard configuration the total cable length should not exceed 1000m, in order to meet the requirement of a maximum cable capacitance of 180nF. *(Taken from M-Bus specifics)*

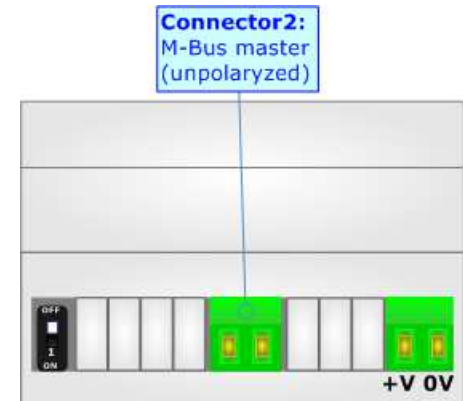

ETHERNET:

The Ethernet connection must be made using Connector3 with at least a Category 5E cable. The maximum length of the cable should not exceed 100m. The cable has to conform to the T568 norms relative to connections in cat.5 up to 100 Mbps. To connect the device to an Hub/Switch is recommended the use of a straight cable, to connect the device to a PC/PLC/other is recommended the use of a cross cable.

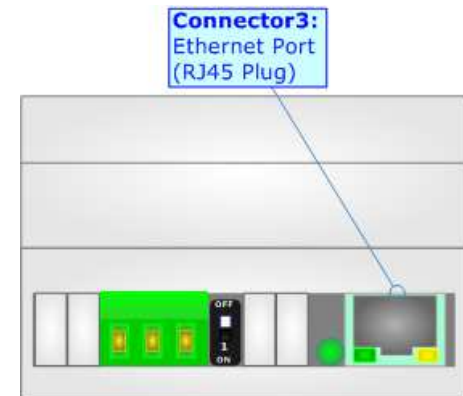

USE OF COMPOSITOR SW67029:

To configure the Converter, use the available software that runs with Windows called SW67029. It is downloadable from the site www.adfweb.com and its operation is described in this document (*this manual is referenced to the last version of the software present on the web site*). The software works with MSWindows (XP, Vista, Seven, 8, 10; 32/64bit).

When launching the SW67029, the window below appears (Fig. 2).

**Note:**

It is necessary to have installed .Net Framework 4.

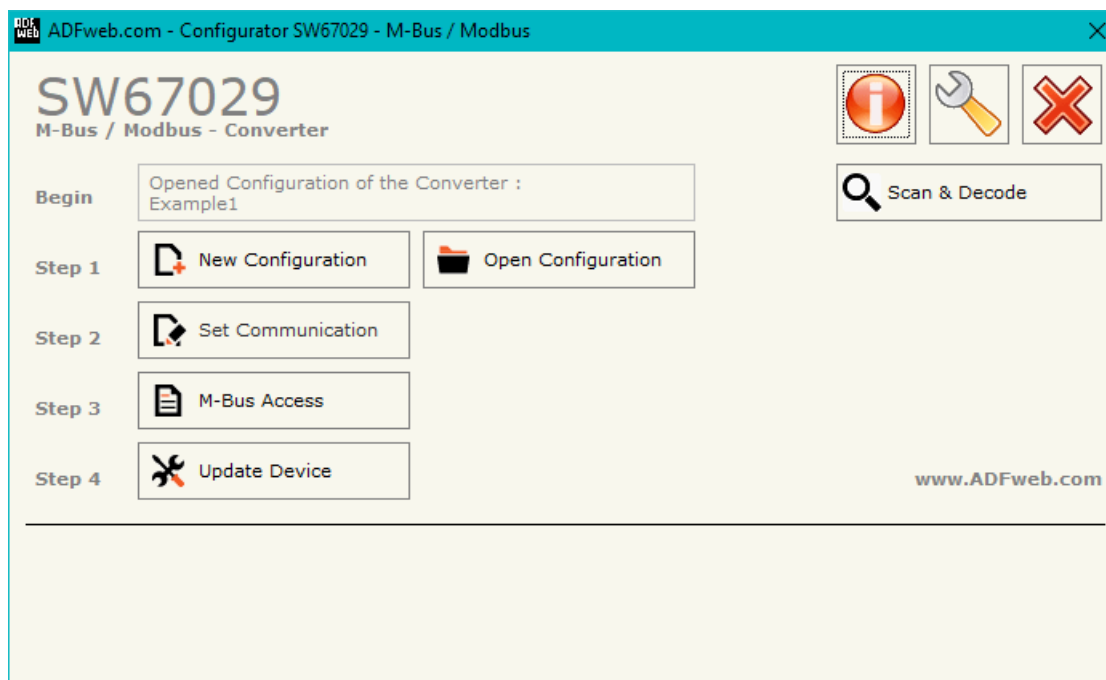
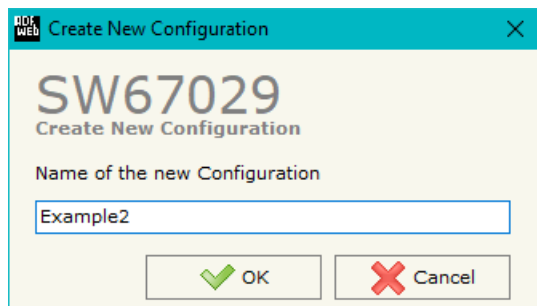

Figure 2: Main window for SW67029

NEW CONFIGURATION / OPEN CONFIGURATION:

The “**New Configuration**” button creates the folder which contains the entire device’s configuration.



A device’s configuration can also be imported or exported:

- To clone the configurations of a programmable “M-Bus master / Modbus slave - Converter” in order to configure another device in the same manner, it is necessary to maintain the folder and all its contents;
- To clone a project in order to obtain a different version of the project, it is sufficient to duplicate the project folder with another name and open the new folder with the button “**Open Configuration**”.

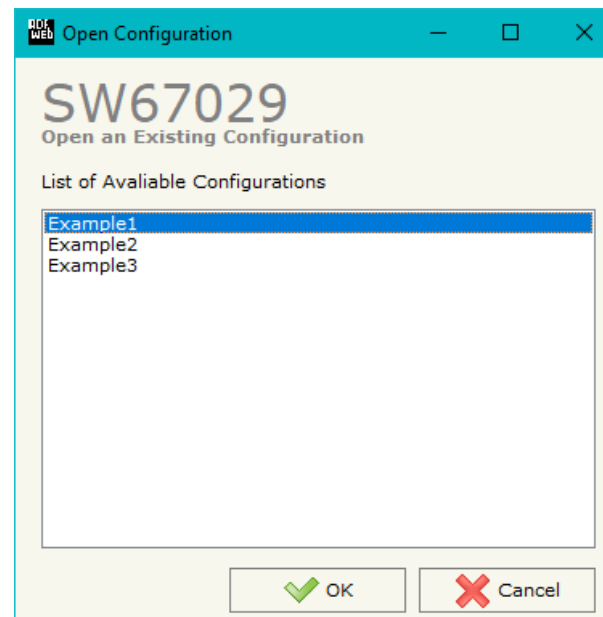

SOFTWARE OPTIONS:

By pressing the “**Settings**” () button there is the possibility to change the language of the software and check the updatings for the compositor.

In the section “Language” it is possible to change the language of the software.

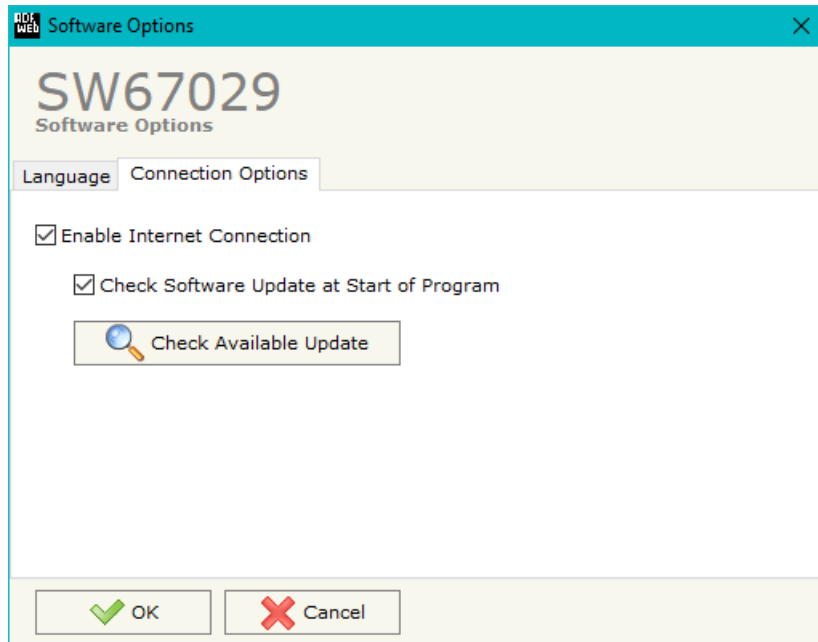

In the section “Connection Options”, it is possible to check if there are some updatings of the software compositor in ADFweb.com website. Checking the option “**Check Software Update at Start of Program**”, the SW67029 check automatically if there are updatings when it is launched.

SET COMMUNICATION:

This section define the fundamental communication parameters of two buses, Modbus and M-Bus.

By Pressing the **"Set Communication"** button from the main window for SW67029 (Fig. 2) the window "Set Communication" appears (Fig. 3).

The window is divided in three sections, one for the Modbus line (Modbus slave), one for the M-Bus and the other for Ethernet.

The means of the fields for Select Device are:

- If the hardware in your possession is the HD67029M-xxx you have to select **"HD67029M"**; otherwise if the hardware in your possess is the HD67029-B2-xxx-xxx you have to select **"HD67029-B2"**.

The means of the fields for "Modbus Slave" are:

- In the field **"Serial"** the serial port to use for the Modbus communication is defined;
- In the field **"Baudrate"** the data rate of the Modbus line is defined;
- In the field **"Parity"** the parity of the Modbus line is defined;
- In the field **"Stop Bits"** the number of Stop bits of the Modbus line is defined;
- In the field **"ID Device"** the Modbus ID to assign to the converter is defined.
- In the field **"Protocol"** the protocol to use in the serial line is defined:
 - **Modbus RTU**;
 - **Modbus ASCII**;
 - **JBUS**;
 - **Binary**: simple protocol defined by Us, whose functions are described in the document "Simple Protocol" downloadable at www.adfweb.com/download/filefold/Simple_Protocol_ENG.pdf;
 - **ASCII**: simple protocol defined by Us, whose functions are described in the document "Simple Protocol" downloadable at www.adfweb.com/download/filefold/Simple_Protocol_ENG.pdf.

The screenshot shows the "Set Communication" window for device SW67029. The window is titled "Set Communication Setting" and contains the following configuration options:

- Select Device:** HD67029-B2
- Modbus Slave:**
 - Serial: RS232
 - Baudrate: 115200
 - Parity: NONE
 - Stop Bits: 1 Stop Bit
 - ID Device: 1
 - Protocol: Modbus RTU
- M-Bus:**
 - Baudrate: 300
 - Parity: EVEN
 - M-Bus Polls: On Request
 - Delay for Cyclic (s): 100
- Ethernet:**
 - IP ADDRESS: 192.168.0.10
 - SUBNET Mask: 255.255.255.0
 - GATEWAY: 192.168.0.1

Buttons: OK, Cancel

Figure 3: "Set Communication" window

The means of the fields for "M-Bus" are:

- In the field "**Baudrate**" the data rate of the M-Bus net is defined;
- In the field "**Parity**" the parity of the M-Bus line is defined;
- In the field "**M-Bus Poll**" the modality of M-Bus polling of the converter is defined. If "On Request" is checked, it sends the request only if a Modbus register is requested; otherwise if "**Cyclic**" is checked, the converter sends the request in M-bus network cyclically;
- In the field "**Delay for Cyclic (s)**" a time expressed in seconds is defined. This time is used for "Cyclic" mode;

The means of the fields for "Ethernet" are (programming port for 'HD67029-B2'):

- In the field "**IP Address**" the IP address of the converter is defined;
- In the field "**Subnet Mask**" the Subnet Mask of the converter is defined;
- In the fields "**GATEWAY**" the default gateway of the net is defined. This feature can be enabled or disabled pressing the Check Box field. This feature is used for going out of the net.

M-BUS

By Pressing the “**M-Bus**” button from the main window for SW67029 (Fig. 2) the window “M-Bus Network” appears (Fig. 4).

In the section “Nodes” it is possible to create the nodes of M-Bus line:

- In the field “**Description**” it is possible to write a short description of the node.
- In the field “**M-Bus Type**” it is possible to select if the node uses M-Bus (on wire) or wM-Bus.

SECTION NODES (M-BUS NODES):

- In order to create a new node it is necessary to select which address use, selecting “**Primary ID**” or “**Secondary ID**”, to makes the requests and then insert the “Primary Address” (from 1 to 250) or the Secondary Address” (from 0 to 99999999) of M-Bus device.
- In the field “**Node State**” it is possible to insert an address Modbus that contain the Status of the M-Bus device. If you don’t need to know this, put this register at 0.
- In the field “**Identification Number**” it is possible to insert an address Modbus that contain the Identification Number of the M-Bus device. You have to read two consecutive registers for knowing the value. If you don’t need to know this, put this register at 0.
- If the field “**Convert BCD in Integer Identification Num.**” is checked the Converter converts the Identification Number that is normally expressed in BCD in a Integer.
- In the field “**Swap Identification Num.**” it is possible to select the swap mode of the Identification Number. If swap isn’t necessary you have to select “None”; otherwise see the section “Swap Identification” (page 30) of this document for select the swap mode.

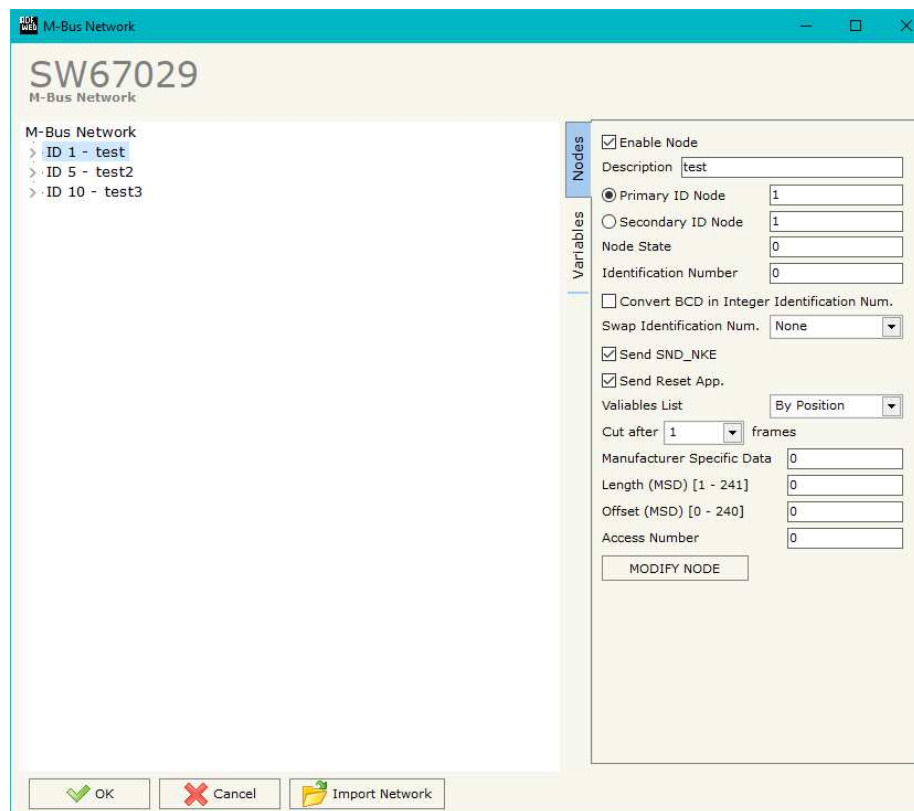

Figure 4: “M-Bus Network” window

- ➔ If the field "**Send SND_NKE**" is checked, the Converter send the "SND_NKE" frame to start the communication.
- ➔ In the field "**Send Reset App.**" Is checked the Converter send the "Application Reset" command to the slave.
- ➔ In the field "**Variables List**" it is possible to select which type of variables definition to use. If is selected "By Type" it is necessary to fill all fields, in the section Variables, with the correct values; otherwise if "By Position" is selected you can insert the progressive number of the variable that you need (page 27 for more information).
- ➔ In the field "**Cut after**" it is possible to select after how many frames stops data requests. It is used when the slave has got many data frames and you don't need to read all them.
- ➔ In the field "**Manufacturing Specific Data**" is possible to insert the starting address Modbus from which you want to save the information of Manufacturer Specific (after DIF=0x0F or DIF=0x1F).
- ➔ In the field "**Length (MSD) [1 - 241]**" is possible to insert the length of the data you need to save.
- ➔ In the field "**Offset (MSD) [0 - 240]**" is possible to insert the offset from where save the data;
- ➔ In the field "**Access Number**" is possible to define a Modbus register where saving the number of accesses to the meter.

For more information about "Manufacturer Specific Data" functions, see page 33.

After that, pressing the "**ADD NODE**" button, a new node appears in the left side of the window. In order to modify a created node it is necessary to select the desired node, change the wrong items and then press the "**MODIFY NODE**" button.

SECTION VARIABLES (BY TYPE):

Selecting the desired node it is possible to add a variable. In order to create a new variable it is necessary to fill these items:

- To use the created variable the field "**Enable Variable**" must be checked. If you have created a variable but for the moment it is unused it is possible to uncheck the field "Enable Variable" without delete it;
- In the field "**Description**" it is possible to write a description of the variable (it isn't a necessary information, it helps the readability of the tree of network);
- The field "**Type of Data**" is used to select the unit of measure;
- In the field "**VIF ASCII String**" insert the string of VIF. It is possible to use this field only if the "Type of Data" is "VIF is in ASCII";
- In the field "**Function Field**" it is necessary to select the type of data;
- The field "**Dimension**" is used to select the dimension of the variable (8, 16, 24, 32, 32 real, 48, 64 bit, Variable Length);
- In the field "**Length(Variable Len)**" insert the length of the data in the case of the dimension is "Variable Length";
- In the field "**Unit**" if it is necessary it is possible to select the unit of that variable. The Unit is used for indicates from which device the data come;
- In the field "**Modbus Register**" it is necessary to insert the value of Modbus Register that contains the data of the M-Bus device. It is possible to insert from Modbus Register "1" to "60000";
- In the field "**Modbus Re Scale**" it is necessary to insert the value of Modbus Register that contains the value of measure scale. If the scale is not necessary, you have to insert the number "0" in this field. It is possible to insert from Modbus Register "1" to "60000";
- In the field "**Storage Number**" if it is necessary it is possible to insert the value of storage counter of that variable. With this field the slave can indicate and transmit various stored counter states or historical values, in the order in which they occur;

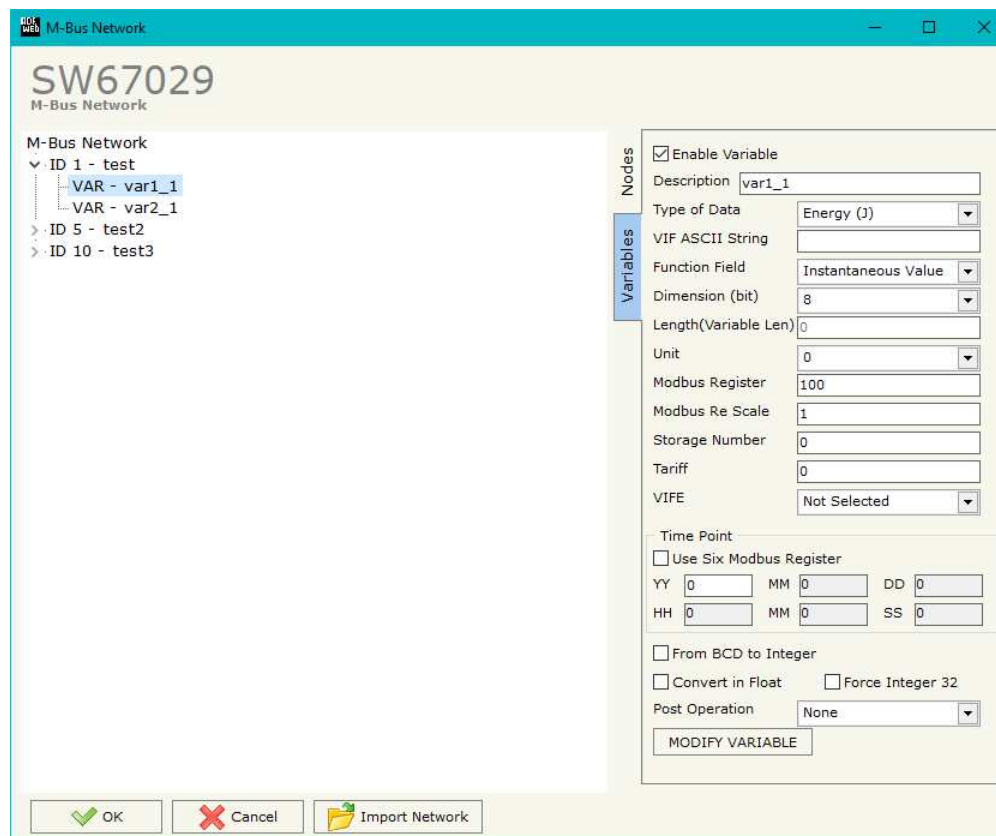

- In the field "**Tariff**" if it is necessary it is possible to insert the value of the tariff of that variable. The Tariff is used for indicates from which device the data come;
- In the field "**VIFE**" it is possible to select a sub-type of "Type of Data";
- If the field "**Use Six Modbus Register**" and the "Type of Data" is "Time Point" it is possible to read the information of Year, Month, Day, Hour, Minutes, Seconds on six consecutive Modbus registers without decoding the data (if not selected the values are the same of the reply of the slave device, so coded with a determinate structure). You have to insert the first Modbus Register.
- If the field "**From BCD to Integer**" is checked the Converter converts the BCD value of variable in Integer format. This happens only if the variable is in BCD format; if it isn't nothing changes.
- If the field "**Convert in Float**" is checked the Converter converts the data into Float type. Every variable occupies two consecutive Modbus Registers and the first one is the one defined in "Modbus Register". In this case the float value is multiplied by the "Modbus Re Scale" automatically;
- If the field "**Force Integer 32**" is checked the Converter maps the variables with a dimension <32 bit in two consecutive Modbus registers as a 32 bit variables;
- In the field "**Post Operation**" it is possible to define an operation on the data read before mapping them on Modbus registers.

Having completed this fields, to add the variable the button "**ADD VARIABLE**" must be pressed.

In order to modify a created variable it is necessary to select the desired variable, change the wrong items and then press the "**MODIFY VARIABLE**" button.

SECTION VARIABLES (BY POSITION):

Selecting the desired node it is possible to add a variable. In order to create a new variable it is necessary to fill these items:

- To use the created variable the field **“Enable Variable”** must be checked. If you have created a variable but for the moment it is unused it is possible to uncheck the field **“Enable Variable”** without delete it;
- In the field **“Description”** it is possible to write a description of the variable (it isn't a necessary information, it helps the readability of the tree of network);
- The field **“Dimension”** is used to select the dimension of the variable (8, 16, 24, 32, 32 real, 48, 64 bit, Variable Length);
- In the field **“Length(Variable Len)”** insert the length of the data in the case of the dimension is **“Variable Length”**;
- In the field **“Modbus Register”** it is necessary to insert the value of Modbus Register that contains the data of the M-Bus device. It is possible to insert from Modbus Register **“1”** to **“60000”**;
- In the field **“Modbus Re Scale”** it is necessary to insert the value of Modbus Register that contains the value of measure scale. If the scale is not necessary, you have to insert the number **“0”** in this field. It is possible to insert from Modbus Register **“1”** to **“60000”**;
- If the field **“Use Six Modbus Register”** and the **“Type of Data”** is **“Time Point”** it is possible to read the information of Year, Month, Day, Hour, Minutes, Seconds on six consecutive Modbus registers without decoding the data (if not selected the values are the same of the reply of the slave device, so coded with a determinate structure). You have to insert the first Modbus Register;
- If the field **“From BCD to Integer”** is checked the Converter converts the BCD value of variable in Integer format. This happens only if the variable is in BCD format; if it isn't nothing changes;

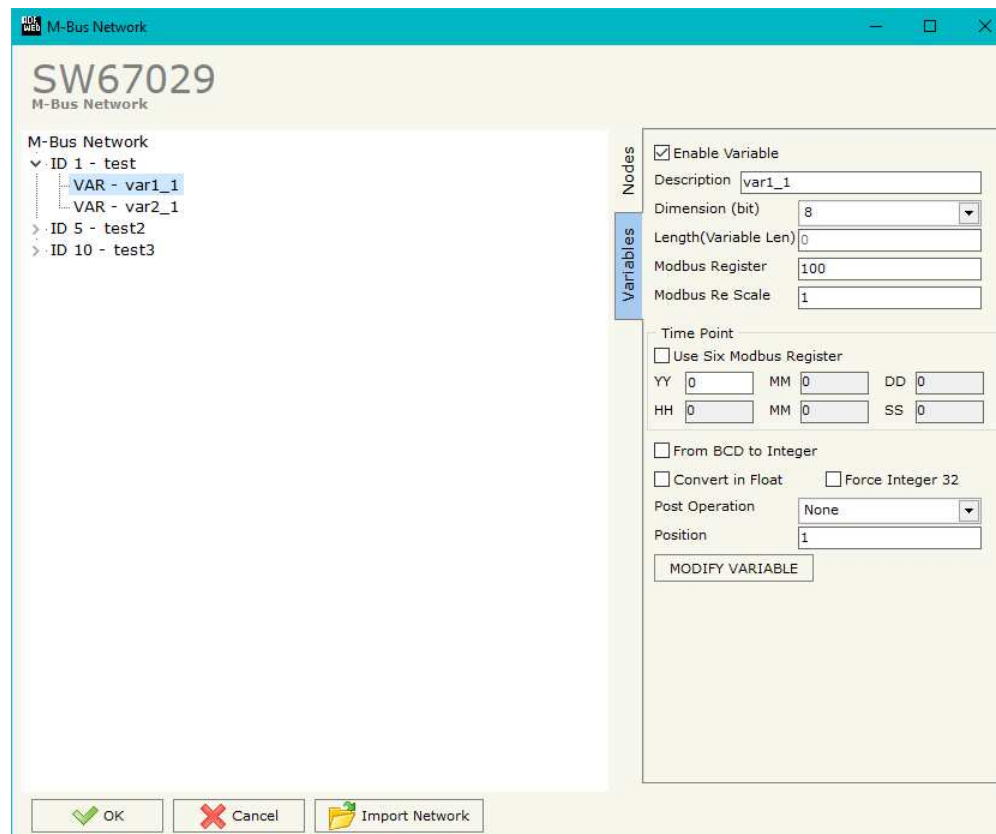

- If the field "**Force Integer 32**" is checked the Converter maps the variables with a dimension <32 bit in two consecutive Modbus registers as a 32 bit variables;
- In the field "**Post Operation**" it is possible to define an operation on the data read before mapping them on Modbus registers.
- In the field "**Position**" insert the number of the variable that you want on Modbus.

Having completed this fields, to add the variable the button "**ADD VARIABLE**" must be pressed.

In order to modify a created variable it is necessary to select the desired variable, change the wrong items and then press the "**MODIFY VARIABLE**" button.

Example:

0x68 - Start Byte
 0xBD - L Fied
 0xBD - L Field
 0x68 - Start Byte
 0x08 - C Field
 0x02 - A Field
 0x72 - CI Field

0x71 - Identification Number (Byte 4of4)
 0x65 - Identification Number (Byte 3of4)
 0x45 - Identification Number (Byte 2of4)
 0x28 - Identification Number (Byte 1of4)
 0x4D - Manufacturer (Byte 2of2)
 0x6A - Manufacturer (Byte 1of2)
 0x81 - Version
 0x04 - Medium
 0x3E - Access Number
 0x27 - Status
 0x00 - Signature (Byte 2of2)
 0x00 - Signature (Byte 1of2)

0x04 - DIF
 0x79 - VIF Identification
 0x00 - Data (Byte 4of4)
 0x00 - Data (Byte 3of4)
 0x00 - Data (Byte 2of4)
 0x00 - Data (Byte 1of4)

0x04 - DIF
 0x06 - VIF Energy
 0x00 - Data (Byte 4of4)
 0x00 - Data (Byte 3of4)
 0x00 - Data (Byte 2of4)
 0x00 - Data (Byte 1of4)

0x44 - DIF
 0x06 - VIF Energy
 0x00 - Data (Byte 4Of4)
 0x00 - Data (Byte 3Of4)
 0x00 - Data (Byte 2Of4)
 0x00 - Data (Byte 1Of4)

... Other Variables
 ...
 0x55 - Check Sum
 0x16 - Stop Byte

Fixed Data Header

First Variable (1)

Second Variable (2)

Third Variable (3)

Identification Number (or Secondary Address) put in the selected register if "Identification Number" is checked

Status of the meter put in the selected register if "Node State" is checked

To be use in the "Position" field

COPY, PASTE AND DELETE ITEMS:

By pressing the right button of the mouse over an item (Variable or Node) it is possible to Copy, Paste and Delete.

It is possible to Copy a variable from a Node and copy it to another Node, or copy a Variable from a project and paste in another one.

It is also possible to copy an entire Node with all its Variables.



Note:

By pressing the **“Import Network”** button is possible to import the file generated by the Analyzer HD67031.

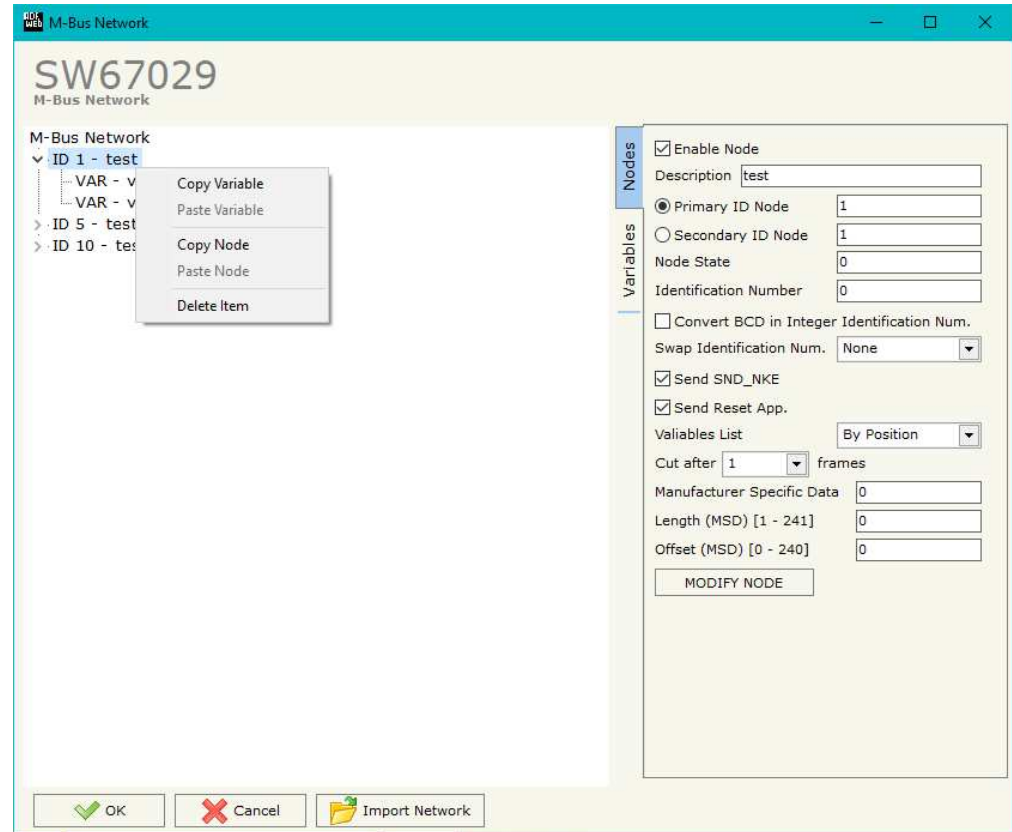

Possible choices for the fields used to create a variable:

Type of Data:

- |_Energy (Wh)
- |_Energy (J)
- |_Volume (m³)
- |_Mass (Kg)
- |_On Time
- |_Operating Time
- |_Power (W)
- |_Power (J/h)
- |_Volume Flow (m³/h)
- |_Volume Flow Ext. (m³/min)
- |_Volume Flow Ext. (m³/s)
- |_Mass Flow (Kg/h)
- |_Flow Temperature (°C)
- |_Return Temperature (°C)
- |_Temperature Difference (K)
- |_External Temperature (°C)
- |_Pressure (bar)
- |_Averaging Duration
- |_Actuality Duration
- |_Type of data in VIFE
- |_Time Point
- |_VIF is in ASCII
- |_Unit for H.C.A.
- |_Fabrication No
- |_(Enhaced) Identification
- |_Bus Address

Function Field:

- |_Instantaneous Value
- |_Minimum Value
- |_Maximum Value
- |_Value During Error State

Dimension (bit):

- |_8
- |_16
- |_24
- |_32
- |_32 real
- |_48
- |_64
- |_Variable Length

VIFE:

- Not Selected
- Credit of the nominal local legal currency units
- Debit of the nominal local legal currency units
- Access Number (transmission count)
- Medium (as in fixed header)
- Manufacturer (as in fixed header)
- Parameter set identification
- Model/Version
- Hardware Version #
- Firmware Version #
- Software Version #
- Customer Location
- Customer
- Access Code User
- Access Code Operator
- Access Code System Operator
- Access Code Developer
- Password
- Error flags (binary)
- Error mask
- Digital Output (binary)
- Digital Input (binary)
- Baudrate [Baud]
- response delay time [bittimes]
- Retry
- First storage # for cyclic storage
- Last storage # for cyclic storage
- Size of storage block
- Storage interval [sec(s)..day(s)]
- Storage interval month(s)
- Storage interval year(s)
- Duration since last readout[sec(s)..day(s)]
- Start (date/time) of tariff
- Duration of tariff (nn=01..11:min to day)
- Period of tariff [sec(s) to day(s)]
- Period of tariff months(s)
- Period of tariff year(s)
- dimensionless/ no VIF
- Volts
- Ampere
- Reset counter
- Comulation counter
- Control signal
- Day of week
- Week number
- Time point of day change
- State of parameter activation
- Special supplier information
- Duration since last comulation [hour(s)..year(s)]
- Operation time battery [hour(s)..year(s)]
- Date and time of battery change
- Energy MWh
- Energy GJ
- Volume
- Mass
- Volume 0,1 feet³
- Volume 0,1 american gallon
- Volume 1 american gallon
- Volume flow 0,001 american gallon/min
- Volume flow 1 american gallon/min
- Volume flow 1 american gallon/h
- Power MW
- Power GJ/h
- Flow Temperature
- Return Temperature
- Temperature Difference
- External Temperature
- Cold/Warm Temperature Limit °F
- Cold/Worm Temperature Limit °C
- Cumul. count max power

- _ per second
- _ per minute
- _ per hour
- _ per day
- _ per week
- _ per month
- _ per year
- _ per revolution/measurement
- _ increment per input pulse on input channel
- _ increment per output pulse on output channel
- _ per liter
- _ per m³
- _ per kg
- _ per K (Kelvin)
- _ per kWh
- _ per GJ
- _ per kW
- _ per (K*I)(Kelvin*liter)
- _ per V (Volt)
- _ per A (Ampere)
- _ multiplied by sek
- _ multiplied by sek/V
- _ multiplied by sek/A
- _ start date(/time) of
- _ VIF contains uncorrected unit instead of corrected unit
- _ Accumulation only if positive contributions
- _ Accumulation of abs value only if negative contributions
- _ upper/lower limit value
- _ # of exceeds of lower/upper limit
- _ Date(/time) of begin/end of first/last lower/upper limit exceed

- _ Duration of limit exceed
- _ Duration of first/last
- _ Date(/time) of first/last begin/end
- _ Multiplicative currection factor
- _ Additive correction constant * unit of VIF (offset)
- _ Multiplicative correction factor: 10³
- _ future value
- _ next VIFE's and data of this block are manufacturer specific
- _ None
- _ Too many DIFE's
- _ Storage number not implemented
- _ Unit number not implemented
- _ Tariff number not implemented
- _ Function not implemented
- _ Data class not implemented
- _ Data size not implemented
- _ Too many VIFE's
- _ Illegal VIF-Group
- _ Illegal VIF-Exponent
- _ VIF/DIF mismatch
- _ Unimplemented action
- _ No data available (undefined value)
- _ Data overflow
- _ Data underflow
- _ Data error
- _ Premature end of record

Swap Identification:

This field is used for select the Swap mode of Identification Number.

At the moment there are these possibilities:

- None;
- Type 1.

Examples:

- Identification Number (Secondary Address): 12345678; Address Register 1000; Convert BCD in Integer Identification Num. not checked.

None	Type 1
1000: 0x1234	1000: 0x5678
1001: 0x5678	1001: 0x1234

- Identification Number (Secondary Address): 12345678; Address Register 1000; Convert BCD in Integer Identification Num. checked.

None	Type 1
1000: 0x00BC	1000: 0x614E
1001: 0x614E	1001: 0x00BC

To know the meaning of value read in the "Modbus Re Scale" field, you must follow this table (x = Value read in Modbus Re Scale):

Description	Range Coding	Range
Energy	$10^{(x-3)}$ Wh	0.001 Wh to 10000 Wh
Energy	$10^{(x)}$ J	0.001 kJ to 10000 kJ
Volume	$10^{(x-6)}$ m ³	0.001 l to 10000 l
Mass	$10^{(x-3)}$ kg	0.001 kg to 10000 kg
On Time	x = 0 Seconds x = 1 Minutes x = 2 Hours x = 3 Days	
Operating Time	coded like On Time	
Power	$10^{(x-3)}$ W	0.001 W to 10000 W
Power	$10^{(x)}$ J/h	0.001 kJ/h to 10000 kJ/h
Volume Flow	$10^{(x-6)}$ m ³ /h	0.001 l/h to 10000 l/h
Volume Flow Ext.	$10^{(x-7)}$ m ³ /min	0.0001 l/min to 1000 l/min
Volume Flow Ext.	$10^{(x-9)}$ m ³ /s	0.001 ml/s to 10000 ml/s
Mass Flow	$10^{(x-3)}$ kg/h	0.001 kg/h to 10000 kg/h
Flow Temperature	$10^{(x-3)}$ °C	0.001 °C to 1 °C
Return Temperature	$10^{(x-3)}$ °C	0.001 °C to 1 °C
Temperature Difference	$10^{(x-3)}$ K	1 mK to 1000 mK
External Temperature	$10^{(x-3)}$ °C	0.001 °C to 1 °C
Pressure	$10^{(x-3)}$ bar	1 mbar to 1000 mbar
Averaging Duration	coded like On Time	
Actuality Duration	coded like On Time	
Time Point	x = 0 Date x = 1 Time&Date	Data type G Data type F
Unit for H.C.A.		dimensionless

Data type F:

2^7	2^6	2^5	2^4	2^3	2^2	2^1	2^0
2^{15}	2^{14}	2^{13}	2^{12}	2^{11}	2^{10}	2^9	2^8
2^{23}	2^{22}	2^{21}	2^{20}	2^{19}	2^{18}	2^{17}	2^{16}
2^{31}	2^{30}	2^{29}	2^{28}	2^{27}	2^{26}	2^{25}	2^{24}

- Min (0 ... 59);
- Hour (0 ... 23);
- Day (1 ... 31);
- Month (1 ... 12);
- Year (0 ... 99);
- Time Invalid (0=Valid, 1=Invalid);
- Summer Time (0=Standard Time, 1=Summer Time);
- Reserved (0).

Data type G:

2^7	2^6	2^5	2^4	2^3	2^2	2^1	2^0
2^{15}	2^{14}	2^{13}	2^{12}	2^{11}	2^{10}	2^9	2^8

- Day (1 ... 31);
- Month (1 ... 12);
- Year (0 ... 99).

For example, if you have defined:

- Type of Data= Energy (J);
- Function Field=Instantaneous Value;
- Dimension= 32 bit;
- Modbus Register=150 (Register 151 declared implicitly because the dimension is 32 bit);
- Modbus Re Scale=152.

After the request, in Modbus register 150 you read 0x0004, in 151 you read 0x5678 and in register 152 is write 0x0006. The value obtained is: $284280 \times 10^{(6)}$ J.

MANUFACTURER SPECIFIC DATA

Using this function is possible to save into Modbus registers the part of M-Bus frame that is coded like Manufacturer Specific Data. Usually these data are at the end of the frame and after a DIF byte with the value 0x0F or 0x1F.

Here an example of the frame and the mentioned data (hexadecimal):

```
68 20 20 68 08 01 72 78 56 34 12 86 04 05 00 08 00 00 00 0C 78 78 56 34 12 0F 11 22 33 44 55 66 77 88 99 AA 74 16
```

If you want to save all ten bytes from Modbus register 200 you have to compile the fields "Manufacturer Specific Data", "Length (MSD) [1 - 241]" and Offset (MSD) [0 - 240] in this way: Manufacturer Specific Data: 200 | Length: 10 | Offset: 0.

On Modbus you will have this result: reg.200=1122h, reg.201=3344h, reg.202=5566h, reg.203=7788h, reg.204=99AAh

If you want to save only the byte 33 and 44 in the Modbus register 200 you have to compile the fields "Manufacturer Specific Data", "Length (MSD) [1 - 241]" and Offset (MSD) [0 - 240] in this way: Manufacturer Specific Data: 200 | Length: 2 | Offset: 2.

On Modbus you will have this result: reg.200=3344h

If you want to save only the byte 66 in the Modbus register 200 you have to compile the fields "Manufacturer Specific Data", "Length (MSD) [1 - 241]" and Offset (MSD) [0 - 240] in this way: Manufacturer Specific Data: 200 | Length: 1 | Offset: 5.

On Modbus you will have this result: reg.200=6600h

UPDATE DEVICE (FOR HD67029M):

By pressing the **“Update Device”** button it is possible to load the created Configuration into the device, and also the Firmware if is necessary, using the RS232 port.

In order to load the parameters or update the firmware in the device, follow these instructions:

- Turn OFF the Device;
- Connect the RS232 cable from your PC to the Converter;
- Put Dip2 of 'Dip-Switch A' in ON position;
- Select the **“COM port”** and press the **“Connect”** button;
- Turn ON the device;
- Check the “Boot state” Led. It must blink quickly;
- Press the **“Next”** button;
- Select which operations you want to do.
- Press the **“Execute update firmware”** button to start the upload;
- When all the operations are “OK” turn OFF the device;
- Put Dip2 of 'Dip-Switch A' in OFF position;
- Disconnect the USB/RS232 cable;
- Turn ON the device.

At this point the configuration/firmware on the device is correctly updated.

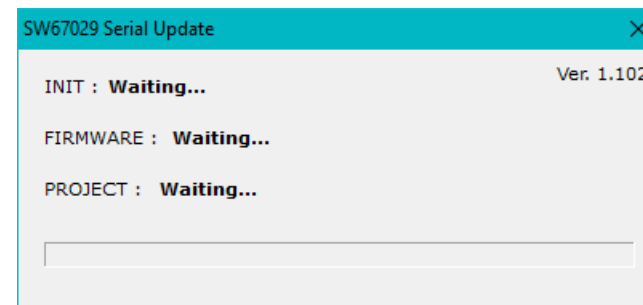
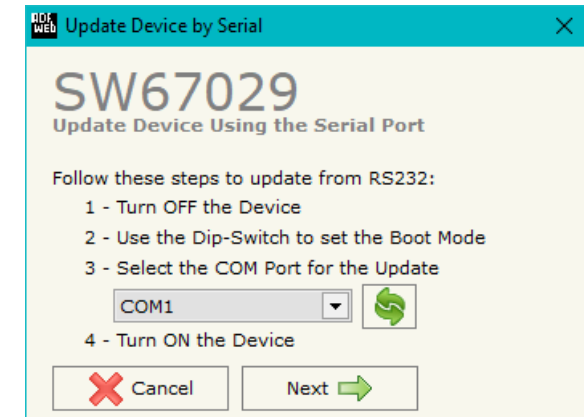

Figure 5a: “Update Device” windows

UPDATE DEVICE (FOR HD67029-B2):

By pressing the **“Update Device”** button, it is possible to load the created Configuration into the device; and also the Firmware, if necessary. This by using the Ethernet port.

If you don't know the actual IP address of the device you have to use this procedure:

- Turn OFF the Device;
- Put Dip1 of 'Dip-Switch A' in ON position;
- Turn ON the device
- Connect the Ethernet cable;
- Insert the IP **“192.168.2.205”**;
- Select which operations you want to do;
- Press the **“Execute update firmware”** button to start the upload;
- When all the operations are “OK” turn OFF the Device;
- Put Dip1 of 'Dip-Switch A' in OFF position;
- Turn ON the device.

If you know the actual IP address of the device, you have to use this procedure:

- Turn ON the Device with the Ethernet cable inserted;
- Insert the actual IP of the Converter;
- Select which operations you want to do;
- Press the **“Execute update firmware”** button to start the upload;
- When all the operations are “OK” the device automatically goes at Normal Mode.

At this point the configuration/firmware on the device is correctly updated.

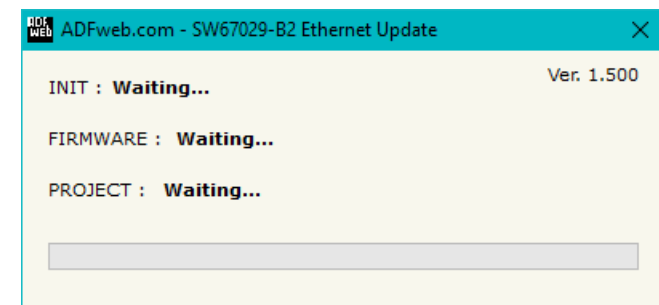
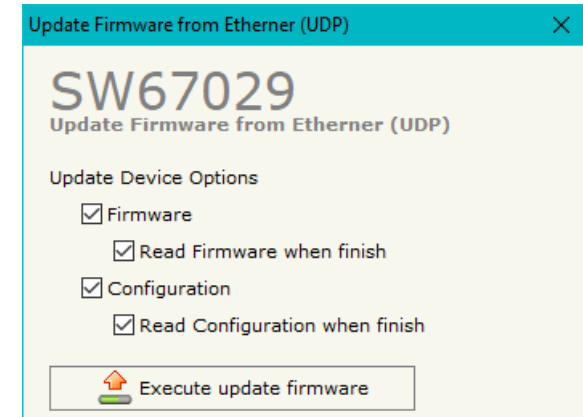
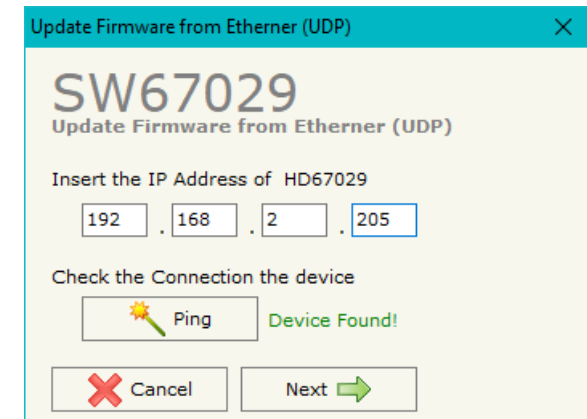

Figure 5b: "Update device" windows



Note:

When you receive the device, for the first time, you also have to update the Firmware in the HD67029 device.



Warning:

If Fig. 6 appears when you try to do the Update try these points before seeking assistance:

- Check if the serial COM port selected is the correct one;
- Check if the serial cable is connected between the PC and the device;
- Try to repeat the operations for the updating;
- Try with another PC;
- Try to restart the PC;
- Check the LAN settings;
- If you are using the program inside a Virtual Machine, try to use in the main Operating System;
- If you are using Windows Seven, Vista, 8 or 10 make sure that you have the administrator privileges;
- In case you have to program more than one device, using the "UDP Update", you have to cancel the ARP table every time you connect a new device on Ethernet. For do this you have to launch the "Command Prompt" and write the command "arp -d". Pay attention that with Windows Vista, Seven, 8, 10 you have to launch the "Command Prompt" with Administrator Rights;
- Pay attention at Firewall lock.

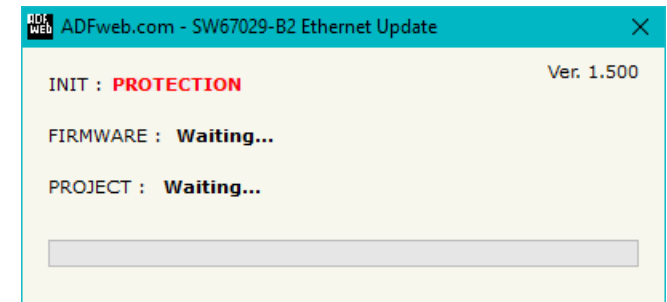
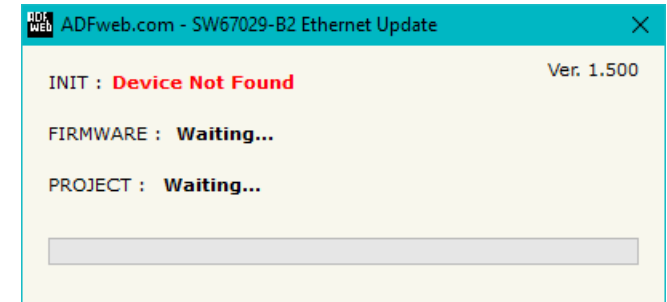



Figure 6: "Error" window



Warning:

In the case of HD67029 you have to use the software "SW67029": www.adfweb.com/download/filefold/SW67029.zip.

SCAN & DECODE FUNCTION:

“SCAN & DECODE” functions are integrated in the configurator software SW67029. It is possible to access to these functions by simple click on the “ Scan & Decode” button.

It has the following characteristics:

- Possibility to scan M-Bus network;
- Automatic decode of M-Bus telegrams;
- Easy connection directly through the Ethernet port of the converters.

For the description of the function, it is possible to refer to this manual: www.adfweb.com/download/filefold/SCAN&DECODE_ENG.pdf

MECHANICAL DIMENSIONS:

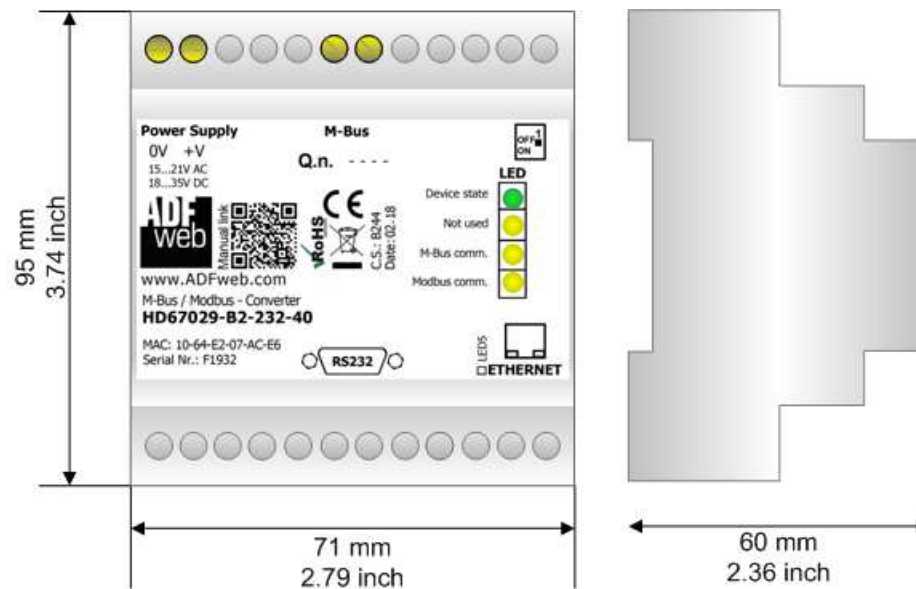

Housing: PVC
Weight: 200g (Approx)

Figure 7: Mechanical dimensions scheme for HD67029-B2-xxx-xxx

ORDERING INFORMATIONS:

The ordering part number is formed by a valid combination of the following:

HD67029 - B 2 - xxx - xxx

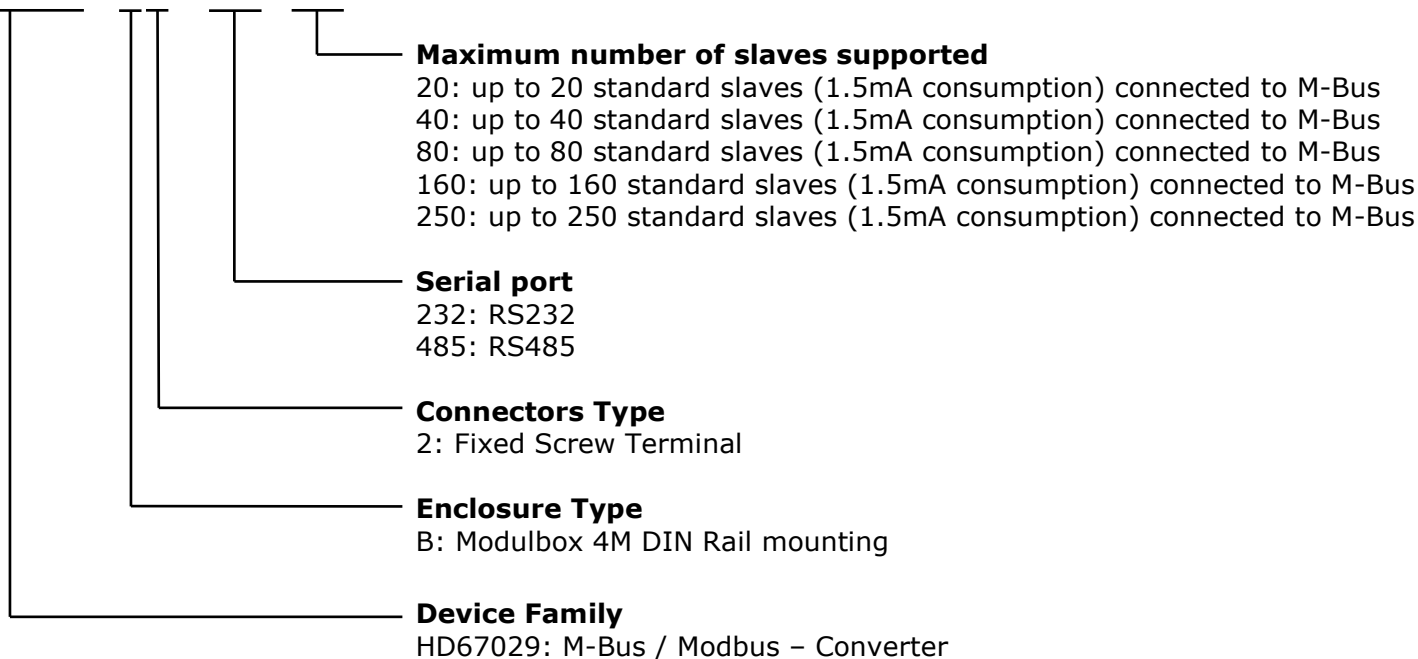

Order Code: HD67029-B2-232-20	- M-Bus master / Modbus slave (RS232) - Converter (up to 20 slaves connected to M-Bus)
Order Code: HD67029-B2-232-40	- M-Bus master / Modbus slave (RS232) - Converter (up to 40 slaves connected to M-Bus)
Order Code: HD67029-B2-232-80	- M-Bus master / Modbus slave (RS232) - Converter (up to 80 slaves connected to M-Bus)
Order Code: HD67029-B2-232-160	- M-Bus master / Modbus slave (RS232) - Converter (up to 160 slaves connected to M-Bus)
Order Code: HD67029-B2-232-250	- M-Bus master / Modbus slave (RS232) - Converter (up to 250 slaves connected to M-Bus)
Order Code: HD67029-B2-485-20	- M-Bus master / Modbus slave (RS485) - Converter (up to 20 slaves connected to M-Bus)
Order Code: HD67029-B2-485-40	- M-Bus master / Modbus slave (RS485) - Converter (up to 40 slaves connected to M-Bus)
Order Code: HD67029-B2-485-80	- M-Bus master / Modbus slave (RS485) - Converter (up to 80 slaves connected to M-Bus)
Order Code: HD67029-B2-485-160	- M-Bus master / Modbus slave (RS485) - Converter (up to 160 slaves connected to M-Bus)
Order Code: HD67029-B2-485-250	- M-Bus master / Modbus slave (RS485) - Converter (up to 250 slaves connected to M-Bus)

ACCESSORIES:

- Order Code: **APW020** - Power Supply for M-Bus Master device that supports up to 20 Slaves
- Order Code: **APW040** - Power Supply for M-Bus Master device that supports up to 40 Slaves
- Order Code: **APW080** - Power Supply for M-Bus Master device that supports up to 80 Slaves
- Order Code: **APW160** - Power Supply for M-Bus Master device that supports up to 160 Slaves
- Order Code: **APW250** - Power Supply for M-Bus Master device that supports up to 250 Slaves
- Order Code: **AC34107** - Null Modem Cable Fem/Fem DSub 9 Pin 1,5 m
- Order Code: **AC34114** - Null Modem Cable Fem/Fem DSub 9 Pin 5 m

DISCLAIMER:

All technical content within this document can be modified without notice. The content of the document is a under continual renewal. For losses due to fire, earthquake, third party access or other accidents, or intentional or accidental abuse, misuse, or use under abnormal conditions repairs are charged to the user. ADFweb.com S.r.l. will not be liable for accidental loss of use or inability to use this product, such as loss of business income. ADFweb.com S.r.l. shall not be liable for consequences of improper use.

OTHER REGULATIONS AND STANDARDS:

WEEE INFORMATION



Disposal of old electrical and electronic equipment (as in the European Union and other European countries with separate collection systems).

— This symbol on the product or on its packaging indicates that this product may not be treated as household rubbish. Instead, it should be taken to an applicable collection point for the recycling of electrical and electronic equipment. If the product is disposed correctly, you will help prevent potential negative environmental factors and impact of human health, which could otherwise be caused by inappropriate disposal. The recycling of materials will help to conserve natural resources. For more information about recycling this product, please contact your local city office, your household waste disposal service or the shop where you purchased the product.

RESTRICTION OF HAZARDOUS SUBSTANCES DIRECTIVE



The device respects the 2002/95/EC Directive on the restriction of the use of certain hazardous substances in electrical and electronic equipment (commonly referred to as Restriction of Hazardous Substances Directive or RoHS).

CE MARKING



The product conforms with the essential requirements of the applicable EC directives.

WARRANTIES AND TECHNICAL SUPPORT:

For fast and easy technical support for your ADFweb.com SRL products, consult our internet support at www.adfweb.com.
Otherwise contact us at the address support@adfweb.com

RETURN POLICY:

If while using your product you have any problem and you wish to exchange or repair it, please do the following:

- Obtain a Product Return Number (PRN) from our internet support at www.adfweb.com. Together with the request, you need to provide detailed information about the problem.
- Send the product to the address provided with the PRN, having prepaid the shipping costs (shipment costs billed to us will not be accepted).

If the product is within the warranty of twelve months, it will be repaired or exchanged and returned within three weeks. If the product is no longer under warranty, you will receive a repair estimate.



ADFweb.com S.r.l.
Via Strada Nuova, 17
IT-31010 Mareno di Piave
TREVISO (Italy)
Phone +39.0438.30.91.31
Fax +39.0438.49.20.99
www.adfweb.com

