

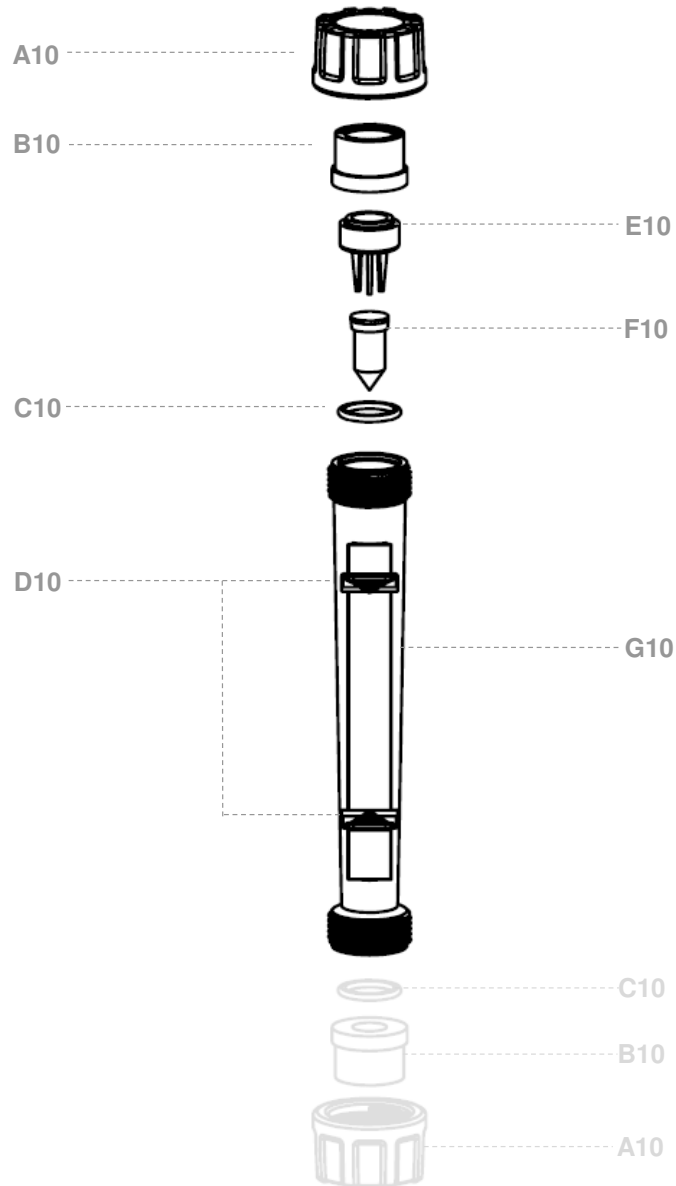



Durchflussmesser DFM 165-200 / Flowmeter DFM 165-200

DN10 - DN15 - DN20 - DN25



Teil Item	Abbildung Picture	Bezeichnung Description	Material Material	d16	d20	d25	d32
				DN10	DN15	DN20	DN25
A10		Überwurfmutter Union nut	PVC - U	533470800	533480800	533490800	533500800
			PP	671180800	671190800	671200800	671210800
			PVDF	1186910800	1186920800	1186930800	1186940800
B10		Einlegeteil Socket end	PVC - U	533110800	533120800	533130800	533140800
			PP	566190800	649840800	649850800	649860800
			PVDF	1102320800	1102330800	1102340800	433280800
C10		O-Ring O-ring	EPDM	53927	53928	53929	53930
			FPM	53936	53937	53938	53939
D10		Sollwertanzeige Setpoint indicator	PE	48543	48543	48543	48543



Gehäusematerial: **PVC-U**
Body material



Messbereich measuring tube	E10 Messrohreinsetzung float trap		F10 Schwebekörper float		G10 Messrohr measuring tube			
	oben top	unten bottom	Standard standard	magnetisch magnetic	DFM 165 DN10	DFM 170 DN15	DFM 185 DN20	DFM 200 DN25
DFM 165								
3-24	48533	-	115500	115501	236175			
5-60	48533	-	115500	115501	236176			
10-100	48533	-	115500	115501	236177			
25-250	48533	-	115500	115501	236178			
DFM 170								
5-50	48534	-	110396	110398		236191		
15-150	48534	-	110396	110398		236192		
25-250	48534	-	110396	110398		236193		
40-400	48534	-	110396	110398		236194		
DFM 185								
15-150	48535	-	110397	110399			236207	
40-400	48535	-	110397	110399			236208	
60-600	48535	-	110397	110399			236209	
100-1000	48535	-	110397	110399			236210	
DFM 200								
25-250	48536	-	110397	110399				236223
40-400	48536	-	110397	110399				236224
100-1000	48536	-	110397	110399				236225
150-1500	48536	-	110397	110399				236226





Gehäusematerial: **PSU**
Body material

Messbereich measuring tube	E10 Messrohreinsetzung float trap		F10 Schwebekörper float		G10 Messrohr measuring tube			
	oben top	unten bottom	Standard standard	magnetisch magnetic	DFM 165 DN10	DFM 170 DN15	DFM 185 DN20	DFM 200 DN25
DFM 165								
3-24	48533	-	48550	48553	236179			
5-60	48533	-	48550	48553	236180			
10-100	48533	-	48550	48553	236181			
25-250	48533	-	48550	48553	236182			
DFM 170								
5-50	48534	-	48551	48554		236195		
15-150	48534	-	48551	48554		236196		
25-250	48534	-	48551	48554		236197		
40-400	48534	-	48551	48554		236198		
DFM 185								
15-150	48535	-	48552	128442			236211	
40-400	48535	-	48552	128442			236212	
60-600	48535	-	48552	128442			236213	
100-1000	48535	-	48552	128442			236214	
DFM 200								
25-250	48536	-	48552	48555				236227
40-400	48536	-	48552	48555				236228
100-1000	48536	-	48552	48555				236229
150-1500	48536	-	48552	48555				236230

PA Gehäusematerial: **PA**
Body material

Messbereich measuring tube	E10 Messrohreinsetz float trap		F10 Schwebekörper float		G10 Messrohr measuring tube			
	oben top	unten bottom	Standard standard	magnetisch magnetic	DFM 165 DN10	DFM 170 DN15	DFM 185 DN20	DFM 200 DN25
								
DFM 165								
3-24	48533	-	48550	48553	236183			
5-60	48533	-	48550	48553	236184			
10-100	48533	-	48550	48553	236185			
25-250	48533	-	48550	48553	236186			
DFM 170								
5-50	48534	-	48551	48554		236199		
15-150	48534	-	48551	48554		236200		
25-250	48534	-	48551	48554		236201		
40-400	48534	-	48551	48554		236202		
DFM 185								
15-150	48535	-	48552	128442			236215	
40-400	48535	-	48552	128442			236216	
60-600	48535	-	48552	128442			236217	
100-1000	48535	-	48552	128442			236218	
DFM 200								
25-250	48536	-	48552	48555				236231
40-400	48536	-	48552	48555				236232
100-1000	48536	-	48552	48555				236233
150-1500	48536	-	48552	48555				236234





PVDF Gehäusematerial: **PVDF**
Body material

Messbereich measuring tube	E10 Messrohreinsetz float trap		F10 Schwebekörper float		G10 Messrohr measuring tube			
	oben top	unten bottom	Standard standard	magnetisch magnetic	DFM 165 DN10	DFM 170 DN15	DFM 185 DN20	DFM 200 DN25
								
DFM 165								
3-24	48533	-	48550	48553	236187			
5-60	48533	-	48550	48553	236188			
10-100	48533	-	48550	48553	236189			
25-250	48533	-	48550	48553	236190			
DFM 170								
5-50	139207	-	48551	48554		236203		
15-150	139207	-	48551	48554		236204		
25-250	139207	-	48551	48554		236205		
40-400	139207	-	48551	48554		236206		
DFM 185								
15-150	139206	-	48552	128442			236219	
40-400	139206	-	48552	128442			236220	
60-600	139206	-	48552	128442			236221	
100-1000	139206	-	48552	128442			236222	
DFM 200								
25-250	139205	-	48552	48555				236235
40-400	139205	-	48552	48555				236236
100-1000	139205	-	48552	48555				236237
150-1500	139205	-	48552	48555				236238

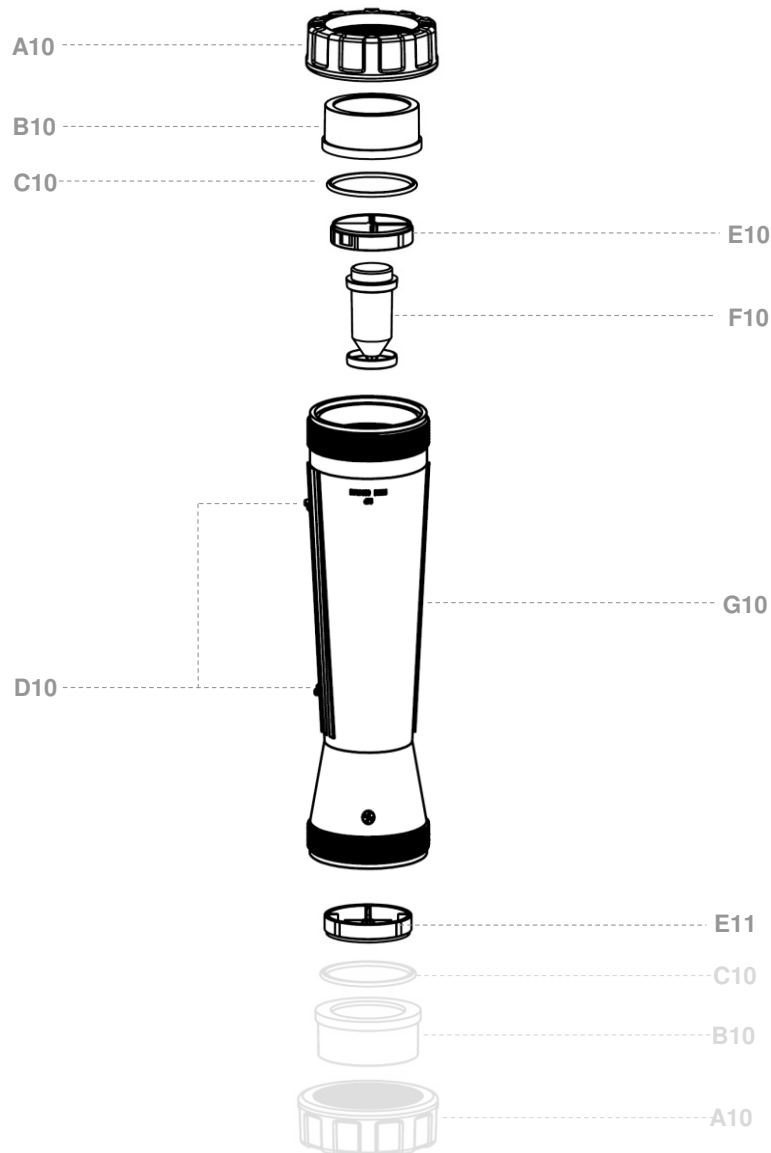
Durchflussmesser DFM 335-350 / Flowmeter DFM 335-350

DN25 - DN32 - DN40 - DN50 - DN65



Teil Item	Abbildung Picture	Bezeichnung Description	Material Material	d32	d40	d50	d63	d75
				DN25	DN32	DN40	DN50	DN65
A10		Überwurfmutter Union nut	PVC - U	533500800	533510800	533520800	533530800	1175420800
			PP	671210800	671220800	671230800	671240800	1175430800
			PVDF	1186940800	1186950800	1186990800	1187000800	1175440800
B10		Einlegteil Socket end	PVC - U	533140800	533150800	533160800	533170800	59460
			PP	649860800	649870800	649880800	649890800	117685
			PVDF	433280800	433300800	433360800	433370800	43338
C10		O-Ring O-ring	EPDM - PVC-U,PSU,PA	53930	53931	53932	53933	234688
			EPDM - PVDF					234689
			FPM - PVC-U,PSU,PA	53939	53940	53941	53942	234696
			FPM - PVDF					234697
D10		Sollwertanzeige Setpoint indicator	PE	45802	45802	45802	45802	45802





Gehäusematerial: PVC-U
Body material

Messbereich measuring tube	E10/E11 Messrohreinsetz float trap		F10 Schwebekörper float		G10 Messrohr measuring tube				
	E10 oben top	E11 unten bottom	Standard standard	magnetisch magnetic	DN25	DN32	DN40	DN50	DN65
DFM 335					DFM 335				
60-600	45780	45780	46383	46389	236239				
100-1000	45780	45780	46383	46389	236240				
200-2000	45782	45782	46383	46389			236261		
300-3000	45782	45782	46383	46389			236262		
600-6000	45783	45783	46384	46391				236275	
1000-10000	45783	45784	46385	46392				236276	
EPDM 2500-25000	234682*	234683*	46387	46394					236317**
FPM 2500-25000	234690*	234691*							236323**
EPDM 10000-50000	234684*	234683*	127830	127831					236318**
FPM 10000-50000	234692*	234691*							236324**
DFM 350					DFM 350				
15-150	45780	115721	124747	127779	127877				
30-300	45780	115721	124747	127779	128998				
60-600	45780	45780	46383	46389	236241				
100-1000	45780	45780	46383	46389	236242				
150-1500	45781	45781	46383	46389		236253			
250-2500	45781	45781	46383	46389		236254			
200-2000	45782	45782	46383	46389			236263		
300-3000	45782	45782	46383	46389			236264		
400-4000	45783	45783	46384	16391				236277	
600-6000	45783	45783	46384	46391				236278	
1000-10000	45785	45784	46385	46392				236279	
EPDM 1500-15000	234682*	234683*	46386	46393					236293**
FPM 1500-15000	234690*	234691*							236302**
EPDM 2500-25000	234682*	234683*	46387	46394					236294**
FPM 2500-25000	234690*	234961*							236303**
EPDM 10000-50000	234684*	234683*	127830	127831					236295**
FPM 10000-50000	234692*	234691*							236304**

* = incl. O-Rings (DFM350 incl. alte und neue Version Messrohreinsetz)
* = incl. O-Rings (DFM350 incl. old and new version of float trap)

** incl. O-Ring und Messrohreinsetz (DFM350 incl. alte und neue Version Messrohreinsetz)
** incl. O-Ring and float trap (DFM350 incl. old and new version of float trap)



 Gehäusematerial: **PSU**
Body material

Messbereich measuring tube	E10/E11 Messrohreinsetz float trap		F10 Schwebekörper float		G10 Messrohr measuring tube				
									
	E10 oben top	E11 unten bottom	Standard standard	magnetisch magnetic	DN25	DN32	DN40	DN50	DN65
DFM 335	DFM 335								
60-600	45780	45780	46383	46389	236243				
100-1000	45780	45780	46383	46389	236244				
200-2000	45782	45782	46383	46389			236265		
300-3000	45782	45782	46383	46389			236266		
600-6000	45783	45783	46384	46391				236280	
1000-10000	45783	45784	46385	46392				236281	
EPDM 2500-25000	234682*	234683*	46387	46394					236319**
FPM 2500-25000	234690*	234691*							236325**
EPDM 10000-50000	234684*	234683*	127830	127831					236320**
FPM 10000-50000	234692*	234691*							236326**
DFM 350	DFM 350								
15-150	45780	115721	124747	127779	127877				
30-300	45780	115721	124747	127779	128998				
60-600	45780	45780	46383	46389	236245				
100-1000	45780	45780	46383	46389	236246				
150-1500	45781	45781	46383	46389		236255			
250-2500	45781	45781	46383	46389		236256			
200-2000	45782	45782	46383	46389			236267		
300-3000	45782	45782	46383	46389			236268		
400-4000	45783	45783	46384	16391				236282	
600-6000	45783	45783	46384	46391				236283	
1000-10000	45785	45784	46385	46392				236284	
EPDM 1500-15000	234682*	234683*	46386	46393					236296**
FPM 1500-15000	234690*	234691*							236305**
EPDM 2500-25000	234682*	234683*	46387	46394					236297**
FPM 2500-25000	234690*	234691*							236306**
EPDM 10000-50000	234684*	234683*	127830	127831					236298**
FPM 10000-50000	234692*	234691*							236307**

* = incl. O-Rings (DFM350 incl. alte und neue Version Messrohreinsetz)
* = incl. O-Rings (DFM350 incl. old and new version of float trap)

** incl. O-Ring und Messrohreinsetz (DFM350 incl. alte und neue Version Messrohreinsetz)
** incl. O-Ring and float trap (DFM350 incl. old and new version of float trap)





 Gehäusematerial: **PA**
Body material

Messbereich measuring tube	E10/E11 Messrohreinsetz float trap		F10 Schwebekörper float		G10 Messrohr measuring tube					
										
	E10 oben top	E11 unten bottom	Standard standard	magnetisch magnetic	DN25	DN32	DN40	DN50	DN65	
DFM 335										
	60-600	45780	45780	46383	46389	236247				
	100-1000	45780	45780	46383	46389	236248				
	200-2000	45782	45782	46383	46389			236269		
	300-3000	45782	45782	46383	46389			236270		
	600-6000	45783	45783	46384	46391				236285	
	1000-10000	45783	45784	46385	46392				236286	
EPDM	2500-25000	234682*	234683*	46387	46394					236321**
FPM		234690*	234691*							236327**
EPDM	10000-50000	234684*	234683*	127830	127831					236322**
FPM		234692*	234691*							236328**
DFM 350										
	15-150	45780	115721	124747	127779	127877				
	30-300	45780	115721	124747	127779	128998				
	60-600	45780	45780	46383	46389	236249				
	100-1000	45780	45780	46383	46389	236250				
	150-1500	45781	45781	46383	46389		236257			
	250-2500	45781	45781	46383	46389		236258			
	200-2000	45782	45782	46383	46389			236271		
	300-3000	45782	45782	46383	46389			236272		
	400-4000	45783	45783	46384	16391				235297	
	600-6000	45783	45783	46384	46391				236288	
	1000-10000	45785	45784	46385	46392				236289	
EPDM	1500-15000	234682*	234683*	46386	46393					236299**
FPM		234690*	234691*							236308**
EPDM	2500-25000	234682*	234683*	46387	46394					236300**
FPM		234690*	234691*							236309**
EPDM	10000-50000	234684*	234683*	127830	127831					236300**
FPM		234692*	234691*							236309**

* = incl. O-Rings (DFM350 incl. alte und neue Version Messrohreinsetz)
* = incl. O-Rings (DFM350 incl. old and new version of float trap)

** incl. O-Ring und Messrohreinsetz (DFM350 incl. alte und neue Version Messrohreinsetz)
** incl. O-Ring and float trap (DFM350 incl. old and new version of float trap)

 Gehäusematerial: **PVDF**
Body material

Messbereich measuring tube	E10/E11 Messrohreinsetzung float trap		F10 Schwebekörper float		G10 Messrohr measuring tube				
									
	E10 oben top	E11 unten bottom	Standard standard	magnetisch magnetic	DN25	DN32	DN40	DN50	DN65
DFM 335					DFM 335				
60-600	-	-	-	-	-				
100-1000	-	-	-	-	-				
200-2000	-	-	-	-					
300-3000	-	-	-	-					
600-6000	-	-	-	-					
1000-10000	-	-	-	-					
EPDM 2500-25000	-	-	-	-					-
FPM 2500-25000	-	-	-	-					-
EPDM 10000-50000	-	-	-	-					-
FPM 10000-50000	-	-	-	-					-
DFM 350					DFM 350				
15-150	45780	115721	124747	127779	127877				
30-300	45780	115721	124747	127779	128998				
60-600	45780	45780	46383	46389	236251				
100-1000	45780	45780	46383	46389	236252				
150-1500	45781	45781	46383	46389		236259			
250-2500	45781	45781	46383	46389		236260			
200-2000	45782	45782	46383	46389			236273		
300-3000	45782	45782	46383	46389			236274		
400-4000	45783	45783	46384	16391				236290	
600-6000	45783	45783	46384	46391				236291	
1000-10000	45785	45784	46385	46392				236292	
EPDM 1500-15000	234685*	234686*	46386	46393					236311**
FPM 1500-15000	234693*	234694*							236314**
EPDM 2500-25000	234685*	234686*							236312**
FPM 2500-25000	234693*	234694*	46387	46394					236315**
EPDM 10000-50000	234687*	234686*	127830	127831					236313**
FPM 10000-50000	234695*	234694*							236316**

* = incl. O-Rings (DFM350 incl. alte und neue Version Messrohreinsetzung)
* = incl. O-Rings (DFM350 incl. old and new version of float trap)

** incl. O-Ring und Messrohreinsetzung (DFM350 incl. alte und neue Version Messrohreinsetzung)
** incl. O-Ring and float trap (DFM350 incl. old and new version of float trap)