

WLC90WL15Q Work Light

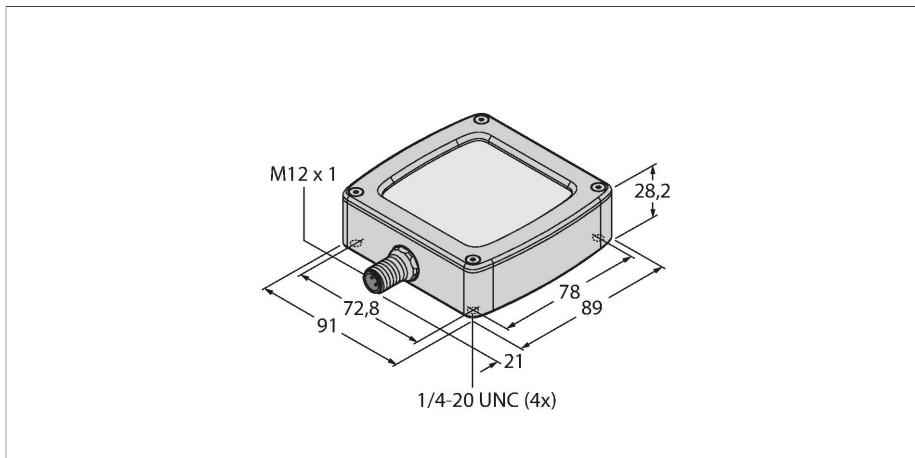

Technical data

Type	WLC90WL15Q
ID	3086522
Signal and display data	
Purpose	LED work light
Function	Area light
Light type	White
Color temperature	6000...+7100 K
Luminous flux lumen	700 lm
Aperture angle degree	15 °
Beam angle	15°
LED service life (L70)	50000 h
Dimmable	Two-stage
Features of color 1	White, Permanently on, 700 lm
Special features	Chemical-resistant Wash down Resistant to chemicals
Electrical data	
Operating voltage	12...30 VDC
DC rated operational current	≤ 850 mA
Input power	10.2 W
Mechanical data	
Cascadable	No
Design	Rectangular, WLC90
Dimensions	91 x 110 x 28.2 mm
Housing material	Metal, AL
Window material	Polycarbonate, clear
Electrical connection	Connector, M12 × 1, PVC

Features

- Operating voltage: 12...30 VDC
- Protection class IP67/IP69K
- Ambient temperature: -40 °C...+70 °C
- Window material: Polycarbonate
- Opening angle: 15°
- Mounted via 4 × 1/4"-20 UNC screws
- Color: White
- Internal temperature regulation
- M12 × 1 male connector, 4-pin, side outlet

Wiring diagram

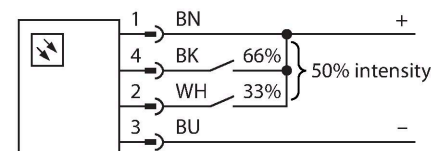

Functional principle

The energy-efficient LED work lights are ideally suited for industrial applications. The color temperature lies in the range of daylight, between 6,000 and 7,100 Kelvin. The flux is 700 lumen. The device is immediately operational upon application of power (10...30 VDC).
Luminous flux
The work lights are available with 8°, 15° and 30° aperture angle.

Technical data

Number of cores	4
Ambient temperature	-40...+70 °C
Storage temperature	-40...+70 °C
Protection class	IP67 IP68 IP68
Tests/approvals	
Approvals	CE, UL

Accessories

SMBAMS70AS	3012127	LMBWLC90PT	3086466
	Mounting bracket, right-angled, stainless steel, for WLC90 work lights, screw kit included		Mounting bracket, right-angled, stainless steel, two-part, two-way rotation, for WLC90 work lights, screw kit included

Accessories

Dimension drawing	Type	ID	
	RKH4.5-2/TFG	6933455	Connection cable, M12 female, straight, 5-pin, stainless steel coupling nut, cable length: 2 m, jacket material: TPE, gray, temperature range -40...+105 °C; other cable lengths and designs available, see www.turck.com
	RKC4.4T-2/TEL	6625013	Connection cable, female M12, straight, 4-pin, cable length: 2 m, sheath material: PVC, black; cULus approval; other cable lengths and qualities available, see www.turck.com
	WKC4.4T-2/TEL	6625025	Connection cable, female M12, angled, 4-pin, cable length: 2 m, sheath material: PVC, black; cULus approval; other cable lengths and qualities available, see www.turck.com